

SHARP

Window Type Air Conditioner
OPERATION MANUAL
窗口式冷氣機
使用說明書

MODELS: AF-X7BCA
型 號: AF-X9BCA
AF-X12BCA
AF-X18BCA



R32

香港電器安全規格

(國際電工委員會規格適合)

Thank you for choosing SHARP R32 window-type air conditioner. Please read this manual thoroughly before using your air conditioner and keep it carefully for future reference.

多謝您購買SHARP R32 窗口式冷氣機。安裝及操作之前，請仔細閱讀本說明書，以便正確使用冷氣機。閱讀後，請妥善保存此說明書，以便日後翻閱。

CONTENTS

Thank you for choosing the air conditioner. Our design is based on the best efficiency and the lowest noise operation and it can keep the room comfortable. Please read this operating manual carefully before operating the unit and keep it for consultation.

Structure mechanism and Installation

The Refrigerant	1
Specialist's Manual	2
Safety Precautions	8
Function	9
Power requirement	10
Installation	11
Notes for installation	14

Operation procedure

Parts identification	15
Air direction adjustment	15
Remote control operation procedure	16
Remote control panel	21
Operation Tips	23

Care and maintenance

Caution	24
Care and maintenance	26
Troubleshooting guide	27
After service	28
Safety operation of flammable refrigerant	29

Please read this operation manual carefully before operating the unit.



WARNING Appliance filled with mildly flammable refrigerant R32. If the refrigerant is leaked and exposed to external ignition source, there is a risk of fire.



CAUTION Before use the appliance, read the operation manual first.



CAUTION Before install the appliance, read the operation manual first.



CAUTION Before repair the appliance, read the operation manual first.

The figures in this manual may be different with the material objects, please refer to the material objects for reference.

Explanation of Symbols



DANGER

Indicates a hazardous situation that, if not avoided, will result in death or serious injury.



WARNING

Indicates a hazardous situation that, if not avoided, could result in death or serious injury.



CAUTION

Indicates a hazardous situation that, if not avoided, may result in minor or moderate injury.

NOTICE

Indicates important but not hazard-related information, used to indicate risk of property damage.



Indicates a hazard that would be assigned a signal word **WARNING** or **CAUTION**.

Exception Clauses

Manufacturer will bear no responsibilities when personal injury or property loss is caused by the following reasons.

1. Damage the product due to improper use or misuse of the product;
2. Alter, change, maintain or use the product with other equipment without abiding by the instruction manual of manufacturer;
3. After verification, the defect of product is directly caused by corrosive gas;
4. After verification, the defects are due to improper operation during transportation of product;
5. Operate, repair, maintain the unit without abiding by instruction manual or related regulations;
6. After verification, the problem or dispute is caused by the quality specification or performance of parts and components that produced by other manufacturers;
7. The damage is caused by natural calamities, bad using environment or force majeure.

If it needs to install, move or maintain the air conditioner, please contact dealer or local service center to conduct it at first. Air conditioner must be installed, moved or maintained by appointed unit. Otherwise, it may cause serious damage or personal injury or death.

When refrigerant leaks or requires discharge during installation, maintenance, or disassembly, it should be handled by certified professionals or otherwise in compliance with local laws and regulations.

● The Refrigerant

- To realize the function of the air conditioner unit, a special refrigerant circulates in the system. The used refrigerant is the R32. The refrigerant is mildly flammable and inodorous. Furthermore, it can lead to explosion under certain conditions. But the flammability of the refrigerant is very low. It can be ignited only by fire.
- Compared to common refrigerants, R32 is a nonpolluting refrigerant with no harm to the ozoneosphere. The influence upon the greenhouse effect is also lower. R32 has got very good thermodynamic features which lead to a really high energy efficiency. The units therefore need a less filling.

WARNING:

Do not use means to accelerate the defrosting process or to clean, other than those recommended by the manufacture. Should repair be necessary, contact your nearest authorized Service Centre.

The installation work shall be carried out by qualified personnel

Any repairs carried out by unqualified personnel may be dangerous.

The appliance shall be stored in a room without continuously operating ignition sources. (for example: open flames, an operating gas appliance or an operating electric heater.)

Do not pierce or burn.

The appliance is using mildly flammable refrigerant R32 and tested to comply with IEC 60335-2-40. There is no minimum room area requirement for the appliance.

The minimum installation height of this appliance is 1000mm.

Appliance filled with mildly flammable refrigerant R32. For repairs, strictly follow manufacturer's instructions only.

Be aware that refrigerants may not contain an odour.

Read specialist's manual.



This appliance can be used by children aged from 8 years and above and persons with reduced physical, sensory or mental capabilities or lack of experience and knowledge if they have been given supervision or instruction concerning use of the appliance in a safe way and understand the hazards involved.

Children shall not play with the appliance.

Cleaning and user maintenance shall not be made by children without supervision.

● Specialist's Manual

- **The following checks shall be applied to installations using flammable refrigerants:**

- the charge size is in accordance with the room size within which the refrigerant containing parts are installed;
- the ventilation machinery and outlets are operating adequately and are not obstructed;
- if an indirect refrigerating circuit is being used, the secondary circuit shall be checked for the presence of refrigerant;
- marking to the equipment continues to be visible and legible. Markings and signs that are illegible shall be corrected;
- refrigeration pipe or components are installed in a position where they are unlikely to be exposed to any substance which may corrode refrigerant containing components, unless the components are constructed of materials which are resistant to being corroded or are suitably protected against being so corroded.

- **Checks to the area**

Prior to beginning work on systems containing flammable refrigerants, safety checks are necessary to ensure that the risk of ignition is minimised. For repair to the refrigerating system, IEC60335-2-40:2018 Annex DD.4.3 to DD.4.7 shall be completed prior to conducting work on the system.

- **Work procedure**

Work shall be undertaken under a controlled procedure so as to minimise the risk of a flammable gas or vapour being present while the work is being performed.

- **General work area**

All maintenance staff and others working in the local area shall be instructed on the nature of work being carried out. Work in confined spaces shall be avoided.

● Specialist's Manual

● **Checking for presence of refrigerant**

The area shall be checked with an appropriate refrigerant detector prior to and during work, to ensure the technician is aware of potentially toxic or flammable atmospheres. Ensure that the leak detection equipment being used is suitable for use with all applicable refrigerants, i.e. non-sparking, adequately sealed or intrinsically safe.

● **Presence of fire extinguisher**

If any hot work is to be conducted on the refrigerating equipment or any associated parts, appropriate fire extinguishing equipment shall be available to hand. Have a dry powder or CO₂ fire extinguisher adjacent to the charging area.

● **No ignition sources**

No person carrying out work in relation to a refrigerating system which involves exposing any pipe work shall use any sources of ignition in such a manner that it may lead to the risk of fire or explosion. All possible ignition sources, including cigarette smoking, should be kept sufficiently far away from the site of installation, repairing, removing and disposal, during which refrigerant can possibly be released to the surrounding space. Prior to work taking place, the area around the equipment is to be surveyed to make sure that there are no flammable hazards or ignition risks. "No Smoking" signs shall be displayed.

● **Ventilated area**

Ensure that the area is in the open or that it is adequately ventilated before breaking into the system or conducting any hot work. A degree of ventilation shall continue during the period that the work is carried out. The ventilation should safely disperse any released refrigerant and preferably expel it externally into the atmosphere.

● **Checks to the refrigeration equipment**

Where electrical components are being changed, they shall be fit for the purpose and to the correct specification. At all times the manufacturer's maintenance and service guidelines shall be followed. If in doubt, consult the manufacturer's technical department for assistance.

The following checks shall be applied to installations using flammable refrigerants:

- the actual refrigerant charge is in accordance with the room size within which the refrigerant containing parts are installed;
- the ventilation machinery and outlets are operating adequately and are not obstructed;
- if an indirect refrigerating circuit is being used, the secondary circuit shall be checked for the presence of refrigerant;
- marking to the equipment continues to be visible and legible. Markings and signs that are illegible shall be corrected;
- refrigerating pipe or components are installed in a position where they are unlikely to be exposed to any substance which may corrode refrigerant containing components, unless the components are constructed of materials which are inherently resistant to being corroded or are suitably protected against being so corroded.

● **Checks to electrical devices**

Repair and maintenance to electrical components shall include initial safety checks

● Specialist's Manual

and component inspection procedures. If a fault exists that could compromise safety, then no electrical supply shall be connected to the circuit until it is satisfactorily dealt with. If the fault cannot be corrected immediately but it is necessary to continue operation, an adequate temporary solution shall be used. This shall be reported to the owner of the equipment so all parties are advised.

Initial safety checks shall include:

- that capacitors are discharged: this shall be done in a safe manner to avoid possibility of sparking;
- that no live electrical components and wiring are exposed while charging, recovering or purging the system.
- that there is continuity of earth bonding.

● Repairs to sealed components

During repairs to sealed components, all electrical supplies shall be disconnected from the equipment being worked upon prior to any removal of sealed covers, etc. If it is absolutely necessary to have an electrical supply to equipment during servicing, then a permanently operating form of leak detection shall be located at the most critical point to warn of a potentially hazardous situation.

Particular attention shall be paid to the following to ensure that by working on electrical components, the casing is not altered in such a way that the level of protection is affected. This shall include damage to cables, excessive number of connections, terminals not made to original specification, damage to seals, incorrect fitting of glands, etc.

- Ensure that the apparatus is mounted securely.
 - Ensure that seals or sealing materials have not degraded to the point that they no longer serve the purpose of preventing the ingress of flammable atmospheres.
- Replacement parts shall be in accordance with the manufacturer's specifications.

NOTE: The use of silicon sealant can inhibit the effectiveness of some types of leak detection equipment. Intrinsically safe components do not have to be isolated prior to working on them.

● Repair to intrinsically safe components

Do not apply any permanent inductive or capacitance loads to the circuit without ensuring that this will not exceed the permissible voltage and current permitted for the equipment in use.

Intrinsically safe components are the only types that can be worked on while live in the presence of a flammable atmosphere. The test apparatus shall be at the correct rating.

Replace components only with parts specified by the manufacturer. Other parts may result in the ignition of refrigerant in the atmosphere from a leak.

● Cabling

Check that cabling will not be subject to wear, corrosion, excessive pressure, vibration, sharp edges or any other adverse environmental effects. The check shall also take into account the effects of aging or continual vibration from sources such as compressors or fans.

● Leak detection methods

Leak detection fluids are suitable for use with most refrigerants but the use of

● Specialist's Manual

detergents containing chlorine shall be avoided as the chlorine may react with the refrigerant and corrode the copper pipe-work.

● **Detection of flammable refrigerants**

Under no circumstances shall potential sources of ignition be used in the searching for or detection of refrigerant leaks. A halide torch (or any other detector using a naked flame) shall not be used.

The following leak detection methods are deemed acceptable for all refrigerant systems.

Electronic leak detectors may be used to detect refrigerant leaks but, in the case of flammable refrigerants, the sensitivity may not be adequate, or may need re-calibration. (Detection equipment shall be calibrated in a refrigerant-free area.)

Ensure that the detector is not a potential source of ignition and is suitable for the refrigerant used. Leak detection equipment shall be set at a percentage of the **LFL** of the refrigerant and shall be calibrated to the refrigerant employed, and the appropriate percentage of gas (25% maximum) is confirmed.

Leak detection fluids are also suitable for use with most refrigerants but the use of detergents containing chlorine shall be avoided as the chlorine may react with the refrigerant and corrode the copper pipe-work.

NOTE: Examples of leak detection fluids are

- bubble method,
- fluorescent method agents.

If a leak is suspected, all naked flames shall be removed/extinguished.

If a leakage of refrigerant is found which requires brazing, all of the refrigerant shall be recovered from the system, or isolated (by means of shut off valves) in a part of the system remote from the leak. Removal of refrigerant shall be according to clause Removal and evacuation.

● **Removal and evacuation**

When breaking into the refrigerant circuit to make repairs - or for any other purpose - conventional procedures shall be used. However, for flammable refrigerants it is important that best practice is followed since flammability is a consideration.

The following procedure shall be adhered to:

- remove refrigerant;
- purge the circuit with inert gas;
- evacuate;
- purge with inert gas;
- open the circuit by cutting or brazing.

The refrigerant charge shall be recovered into the correct recovery cylinders. For appliances containing flammable refrigerants, the system shall be purged with oxygen-free nitrogen to render the appliance safe for flammable refrigerants. This process may need to be repeated several times. Compressed air or oxygen shall not be used for purging refrigerant systems.

For appliances containing flammable refrigerants, refrigerants purging shall be achieved by breaking the vacuum in the system with oxygen-free nitrogen and continuing to fill until the working pressure is achieved, then venting to atmosphere, and finally pulling down to a vacuum. This process shall be repeated until no refrigerant is within the system. When the final

● Specialist's Manual

oxygen-free nitrogen charge is used, the system shall be vented down to atmospheric pressure to enable work to take place. This operation is absolutely vital if brazing operations on the pipe-work are to take place.

Ensure that the outlet for the vacuum pump is not close to any potential ignition sources and that ventilation is available.

● Charging procedures

In addition to conventional charging procedures, the following requirements shall be followed.

- Ensure that contamination of different refrigerants does not occur when using charging equipment. Hoses or lines shall be as short as possible to minimise the amount of refrigerant contained in them.
- Cylinders shall be kept in an appropriate position according to the instructions.
- Ensure that the refrigerating system is earthed prior to charging the system with refrigerant.
- Label the system when charging is complete (if not already).
- Extreme care shall be taken not to overfill the refrigerating system.

Prior to recharging the system, it shall be pressure-tested with the appropriate purging gas. The system shall be leak-tested on completion of charging but prior to commissioning. A follow up leak test shall be carried out prior to leaving the site.

● Decommissioning

Before carrying out this procedure, it is essential that the technician is completely familiar with the equipment and all its detail. It is recommended good practice that all refrigerants are recovered safely. Prior to the task being carried out, an oil and refrigerant sample shall be taken in case analysis is required prior to reuse of reclaimed refrigerant. It is essential that electrical power is available before the task is commenced.

a) Become familiar with the equipment and its operation.

b) Isolate system electrically.

c) Before attempting the procedure, ensure that:

- mechanical handling equipment is available, if required, for handling refrigerant cylinders;
- all personal protective equipment is available and being used correctly;
- the recovery process is supervised at all times by a competent person;
- recovery equipment and cylinders conform to the appropriate standards.

d) Pump down refrigerant system, if possible.

e) If a vacuum is not possible, make a manifold so that refrigerant can be removed from various parts of the system.

f) Make sure that cylinder is situated on the scales before recovery takes place.

g) Start the recovery machine and operate in accordance with manufacturer's instructions.

h) Do not overfill cylinders. (No more than 80% volume liquid charge).

i) Do not exceed the maximum working pressure of the cylinder, even temporarily.

j) When the cylinders have been filled correctly and the process completed, make sure that the cylinders and the equipment are removed from site promptly and all isolation valves on the equipment are closed off.

● Specialist's Manual

k) Recovered refrigerant shall not be charged into another refrigeration system unless it has been cleaned and checked.

● Labelling

Equipment shall be labelled stating that it has been de-commissioned and emptied of refrigerant. The label shall be dated and signed. For appliances containing flammable refrigerants, ensure that there are labels on the equipment stating the equipment contains flammable refrigerant.

● Recovery

When removing refrigerant from a system, either for servicing or decommissioning, it is recommended good practice that all refrigerants are removed safely.

When transferring refrigerant into cylinders, ensure that only appropriate refrigerant recovery cylinders are employed. Ensure that the correct number of cylinders for holding the total system charge are available. All cylinders to be used are designated for the recovered refrigerant and labelled for that refrigerant (i.e. special cylinders for the recovery of refrigerant). Cylinders shall be complete with pressure-relief valve and associated shut-off valves in good working order. Empty recovery cylinders are evacuated and, if possible, cooled before recovery occurs.

The recovery equipment shall be in good working order with a set of instructions concerning the equipment that is at hand and shall be suitable for the recovery of all appropriate refrigerants including, when applicable, flammable refrigerants. In addition, a set of calibrated weighing scales shall be available and in good working order. Hoses shall be complete with leak-free disconnect couplings and in good condition. Before using the recovery machine, check that it is in satisfactory working order, has been properly maintained and that any associated electrical components are sealed to prevent ignition in the event of a refrigerant release. Consult manufacturer if in doubt.

The recovered refrigerant shall be returned to the refrigerant supplier in the correct recovery cylinder, and the relevant waste transfer note arranged. Do not mix refrigerants in recovery units and especially not in cylinders.

If compressors or compressor oils are to be removed, ensure that they have been evacuated to an acceptable level to make certain that flammable refrigerant does not remain within the lubricant. The evacuation process shall be carried out prior to returning the compressor to the suppliers. Only electric heating to the compressor body shall be employed to accelerate this process. When oil is drained from a system, it shall be carried out safely.

Safety Precautions

Warning

This appliance can be used by children aged from 8 years and above and persons with reduced physical, sensory or mental capabilities, or lack of experience and knowledge if they have been given supervision or instruction concerning use of the appliance in a safe way and understand the hazards involved.

Children shall not play with the appliance.

Cleaning and user maintenance shall not be made by children without supervision.

The air conditioner should be installed in accordance with national wiring regulation. Air Conditioner should be properly grounded. Incorrect grounding may cause electric shock.

- Do not connect air conditioner to multi-purpose socket. Otherwise, it may cause fire hazard.
- Do install the air switch. If not, it may cause malfunction.
- Do not spill water on the remote controller, otherwise the remote controller may be broken.
- Do not spray water on air conditioner. It may cause electric shock or malfunction.
- Do not extend fingers or objects into air inlet or air outlet. It may cause personal injury or damage.
- Do not step on air conditioner, or put heavy objects. It may cause damage or personal injury.
- Do not block air outlet or air inlet. It may cause malfunction.
- Do disconnect power supply when cleaning air conditioner. Otherwise, it may cause electric shock.
- Do not repair air conditioner by yourself. It may cause electric shock or damage. Please contact dealer when you need to repair air conditioner.
- Maintenance must be performed by qualified professionals. Otherwise, it may cause injury or damage.
- The appliance is not to be used by persons (including children) with reduced physical, sensory or mental capabilities, or lack of experience and knowledge, unless they have been given supervision or instruction.
- Children being supervised not to play with the appliance.

Please install the devices for short-circuit protection and electrical leakage protection when installing the air conditioner.

According to the local safety regulations, use qualified power supply circuit and circuit break.

Working temperature range

※ Operating Temperature Range		
	Indoor side DB/WB(°C)	Outdoor side DB/WB(°C)
Maximum cooling	32/23	43/-

The operating temperature range (outdoor temperature) for cooling only unit is 18°C~ 43°C.

● Function

Introduction

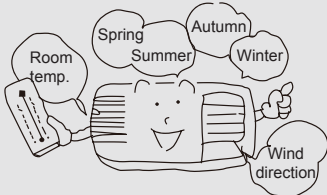

Window type room air conditioners can regulate the room temperature and dry the room. It is convenient for your work, study and life. It can be widely used in residence, shop, hotel, office, library and laboratory, and so on.

Cooling in summer

In hot summer, Air conditioner can cool down the room air by transferring heat out.

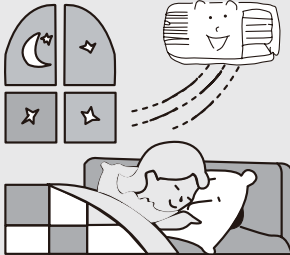

Dehumidifying in rainy or humid season

Without reducing the room temp., air conditioner can dehumidify and make the room air dry and comfortable.





● Operating Condition

- Please operate air conditioner in the correct conditions as following.

COOL mode operation	DRY mode operation
<p>Outdoor temperature should be in range of 18°C to 43°C, otherwise it is possible for air conditioner to breakdown. Room humidity should be lower than 90%. Otherwise, it is possible for air conditioner to dew at air conditioner surface and even drop water after running for so much time. But this is normal.</p>	<p>Outdoor temperature should be in range of 18°C to 43°C, otherwise it is possible for air conditioner to breakdown.</p>

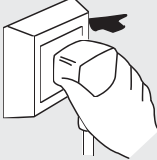
Power requirement

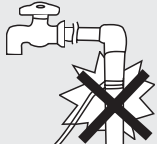
	<p>* The electric components will be damaged when the voltage is too high. If the voltage is too low, the compressor will vibrate violently to damage the refrigerant system and easily cause the compressor and electric components not work.</p>	
	<p>The ground must be connected. * Special socket must be used. Furthermore, the socket and wiring must conform to the wiring regulations. And the earthing method must be reliable. * In fixed circuit, there must be electricity leakage protection switch of enough power capacity and air switch with enough space.</p>	
<p>Earth wire To ensure the reliable earthing, please do not connect earth wire to the following places:</p>		
<p style="text-align: center;">Water pipe</p> 		

● Installation

Installation precaution:

Window type conditioner is so valuable and the improper installation of it will cause a lot of damage! Please associate the professional technician to install the unit and don't install it by yourself. Otherwise, we are not responsible for the damage like this.



Location:

- The minimum installation height of this appliance is 1000mm.
- The condensation water must be drained away conveniently.
- Install air conditioner unit far away from TV set or radio etc. to avoid disturbing video or voice.
- In salt and coastal area or place where is near thermal springs and polluted by sulphurous gas, or other special areas, please contact seller before use.
- Avoid a place where is possible for inflammable gas to leak out.
- Avoid other heat sources or direct sun light.
- Avoid a place where is easy for children to touch.
- Don't use the unit in the immediate surroundings of a laundry, a bath, a shower or a swimming pool.
- For window type air conditioner with remote control, install in a location where is strong electromagnetic disturbance, you should contact the seller in advance to avoid the malfunction in use.

How to install:

- Choose a location where there are no any obstacle surrounding the unit, and the plug is accessible.
- Prepare the installation hole slightly bigger than unit size.
- Choose the installation space according to the following diagram.

The distance between the air conditioner and the around obstacles should meet the requirement as below: over 300mm (upper side), over 500mm (left side), over 500mm (right side), over 1500mm (front side) and over 500mm (rear side).

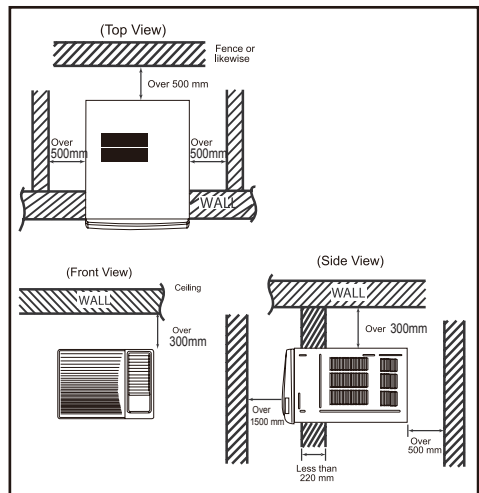

Installation procedure:

- 1) Remove the sticker from the front panel.
- 2) Put the unit into the installation hole.
 - When installing the unit, it should be slanted down to the back to avoid the enlargement of noise or vibration. (Slant between 6-10mm.) (Shown at right figure.)
 - The installation place should be strong enough to avoid the enlargement of noise or vibration.
- 3) Fill up sews in the cabinet with sponge or foam.

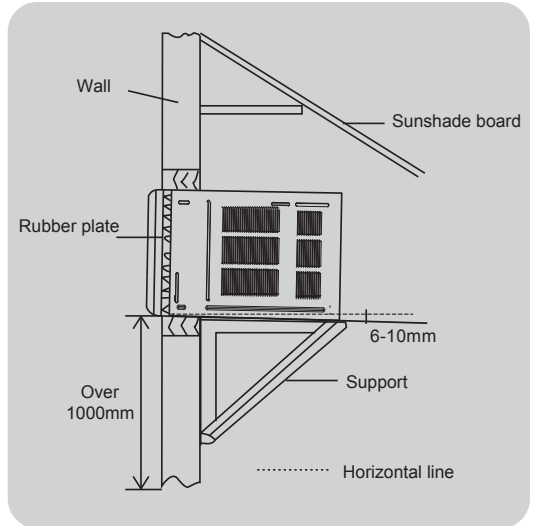

Installation requirement:

- Use iron support
The installation hole should be strong enough to support the air conditioner. If it cannot, iron support has to be used outdoors. Iron support should be fixed on the building (Shown at right figure.)
- Use sunshade board
Air conditioner should avoid anything to be dropped into it and avoid direct sunshine. If there is no cover on it, you should contact the seller for installing the sunshade board. When installing the sunshade board, don't let it block the air inlet at the side grille.

Drain water method 1:

To get the maximum cooling efficiency, the air conditioner is designed to splash the condensate on the condenser coil.

If the splashing sound annoys you, you can provide an outside drain by using the following procedure, which may however cause a small loss of performance.

1. There is a drainage outlet at the back of the unit.
2. Remove cover from the drainage outlet, and then connect drainage joint to it with screw.
3. Connect the drain hose to the outlet.

Note:

Drain hose or tubing can be purchased locally to satisfy your particular needs.

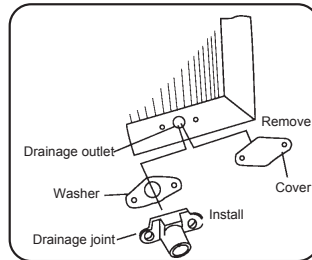

Drain water method 2:

To get the maximum cooling efficiency, the air conditioner is designed to splash the condensation water on the condenser coil.

To the cooling only unit, If the splashing sound annoys you, you can provide an outside drain by using the following procedure, which may however cause a small loss of performance.

1. Slide out the chassis from the cabinet.
2. Remove the rubber plug from the body base plate.
3. Install the drain pan to the corner of the cabinet with 2 screws.
4. Connect the drain hose to the outlet on the drain pan bottom.
5. Slide the chassis into its original place in the cabinet.

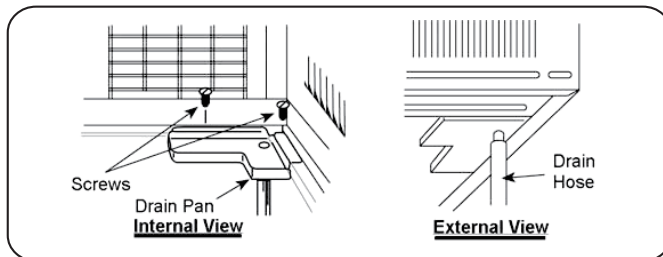

Note:

- Drain pan and drain hose must be installed before using reverse cycle models.
- Drain hose or tubing can be purchased locally to satisfy your particular needs.

● Notes for installation

Remove

Before removing air conditioner to the other place, you should contact the seller firstly. Then it must be done under the direction of the professional technician. In addition, the charge of this must be paid.

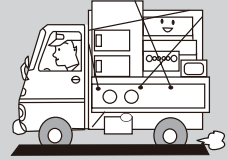

Noise

- Install in a location where is firm enough to avoid the enlargement of noise and vibration.
- Don't put anything in front of the outlet of the unit to avoid increasing noise.
- Be sure that hot air or noise will not inconvenience neighbors.
- Please contact the seller as soon as there is strange noise during operation.
- Please use the safety support.



Electric wiring

- Must connect with ground reliably.
- The exclusive circuit must be used. But removable socket can't be used because poor contact of it can cause over heat or fire.
- Don't pull the power cord strongly.
- In fixed circuit, there must be electricity leakage protection switch and leakage current is less than 30mA.
- Connecting method between air conditioners and power cord and interconnecting method of each individual element with one another should accord with wiring diagram on the unit.
- The air conditioner should be installed in accordance with national wiring regulation.
- An all-pole disconnection switch having a contact separation of at least 3mm in all poles should be connected in fixed wiring.
- Air switch (thermal-magnetic breaker) should be installed in the circuit and its capacity is 10A (9K、12K) / 16A (18K).
- If the supply cord is damaged, it must be replaced by the manufacturer or your dealer or a qualified person to avoid a hazard.
- All The electrical work must be done according to the local wiring regulations.



● Parts identification

Panel outlook picture, just for reference, please take the real unit as standard.

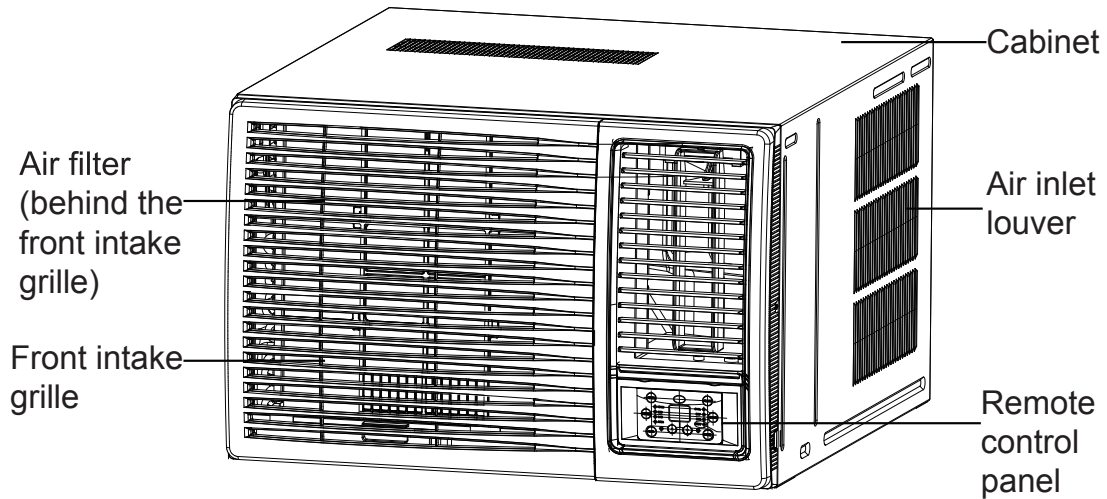

Air direction adjustment

Vertical airflow direction vane

(Airflow direction adjustment up and down).

The vertical airflow direction vane is controlled by positioning the vane to discharge the air upwards, downwards or straight out.

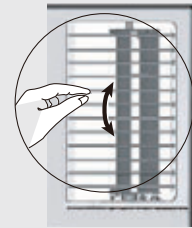

Remote control operation procedure

Buttons on remote controller

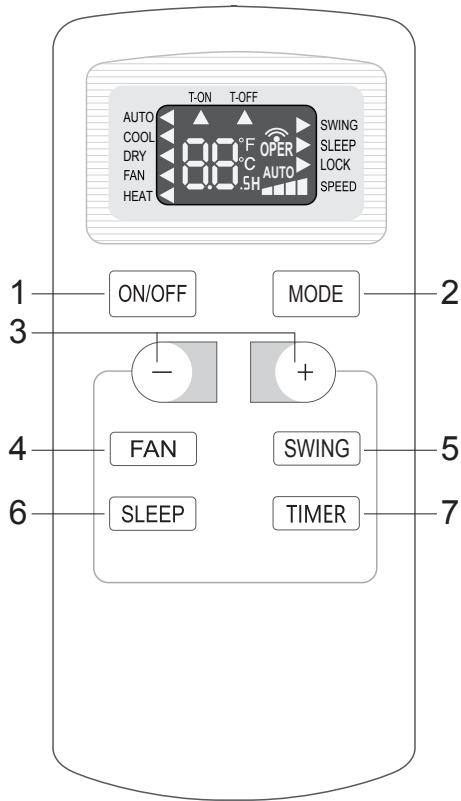

- ① ON/OFF button
- ② MODE button
- ③ +/- button
- ④ FAN button
- ⑤ SWING button
- ⑥ SLEEP button
- ⑦ TIMER button

Introduction for icons on display screen

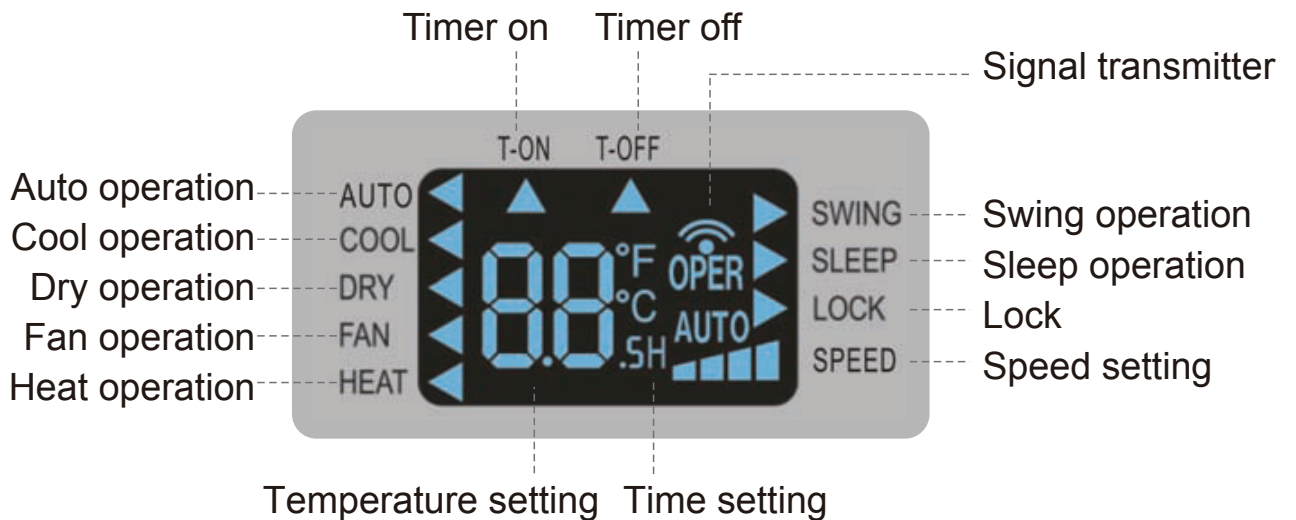

Introduction for buttons on remote controller

Note:

- This is a general use remote controller, it could be used for the air conditioners with multifunction; For some function, which the model doesn't have, if press the corresponding button on the remote controller that the unit will keep the original running status.
- When power is connected (stand by condition), you can operate the air conditioner through the remote controller.
- When unit is on, each time you press the button on remote controller, the sending signal icon "📶" on the display of remote controller will blink once. If the air conditioner gives out a beep sound, it means the signal has been sent.
- When unit is off, set temperature will be displayed on the remote controller (If the light of the unit display is turned on, the corresponding icon will be displayed); When unit is on, it will display the icon of the on-going function.

1 ON/OFF button

Press this button to turn unit on/off.

2 MODE button

Pressing this button once can select your required mode circularly as below (the corresponding icon "◀" will be lit up after the mode is selected):



- When selecting auto mode, air conditioner will operate automatically according to ambient temperature. Set temperature can't be adjusted and won't be displayed either. Press FAN button to adjust fan speed.
- When selecting cool mode, air conditioner will operate under cool mode. Then press + or - button to adjust set temperature. Press FAN button to adjust fan speed.
- When selecting dry mode, air conditioner will operate at low fan speed under dry mode. In dry mode, fan speed can't be adjusted.
- When selecting fan mode, air conditioner will operate in fan mode only. Then press FAN button to adjust fan speed.
- When selecting heat mode, air conditioner will operate under heat mode. Then press + or - button to adjust set temperature. Press FAN button to adjust fan speed. (Cooling only unit can't receive heating mode signal. If set HEAT mode by remote controller, press ON/OFF button can't turn on the air conditioner.)

3 + / - button

- Pressing + or - button once will increase or decrease set temperature by 1°F(°C). Hold + or - button for 2s, set temperature on remote controller will change quickly. Release the button after your required set temperature is reached.
- When setting Timer On or Timer Off, press + or - button to adjust the time. (See TIMER Button for setting details)

Introduction for buttons on remote controller

4 FAN button

Pressing this button can select fan speed circularly as: AUTO, SPEED 1 (▲), SPEED 2 (▲▲), SPEED 3 (▲▲▲), SPEED 4 (▲▲▲▲) (unavailable in this air conditioner. Speed 4 is the same with speed 3.).

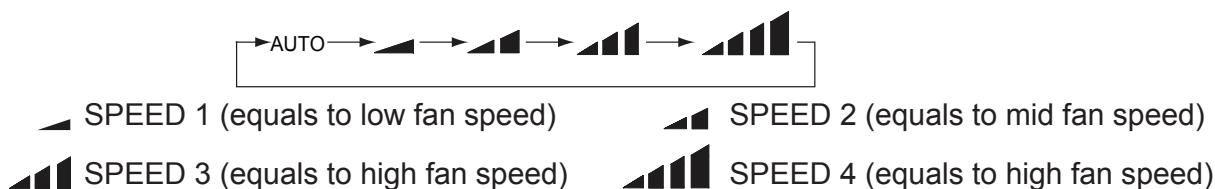

Note:

- Under Auto speed, air conditioner will select proper fan speed automatically according to ambient temperature.
- Fan speed can't be adjusted under Dry mode.

5 SWING button

Press this button to turn on left & right air swing.

6 SLEEP button

Under Cool, Dry and Heat mode, press this button to turn on Sleep function. Press this button to cancel Sleep function. Under Fan and Auto mode, this function is unavailable.

7 TIMER button

- When unit is on, press this button to set Timer Off. T-OFF and H icon will be blinking. Within 5s, press + or - button to adjust the time for Timer Off. Pressing + or - button once will increase or decrease the time by 0.5h. Hold + or - button for 2s, time will change quickly. Release the button after your required set time is reached. Then press TIMER button to confirm it. T-OFF and H icon will stop blinking.
- When unit is off, press this button to set Timer On. T-ON and H icon will be blinking. Within 5s, press + or - button to adjust the time for Timer On. Pressing + or - button once will increase or decrease the time by 0.5h. Hold + or - button for 2s, time will change quickly. Release the button after your required set time is reached. Then press TIMER button to confirm it. T-ON and H icon will stop blinking.
- Cancel Timer On/Off: If Timer function is set up, press TIMER button once to review the remaining time. Within 5s, press TIMER button again to cancel this function.

Introduction for buttons on remote controller

Note:

- Range of time setting is: 0.5~24h.
- The interval between two motions can't exceed 5s, otherwise the remote controller will exit setting status.

Function introduction for combination buttons

Child lock function

Press "+" and "-" buttons simultaneously can turn on or turn off child lock function. When child lock function is started up, LOCK indicator on remote controller is ON. If you operate the remote controller, remote controller won't send signal.

Temperature display switchover function

Under OFF status, press "-" button and "MODE" button simultaneously can switch between °C and °F.

Light function

Under switch-on or switch-off state, you may hold "+" and "FAN" buttons simultaneously for 3 seconds to set the lamp on or off and send the code. After being energized the lamp is defaulted on.

Operation guide

1. After putting through the power, press "ON/OFF" button on remote controller to turn on the air conditioner.
2. Press "MODE" button to select your required mode: AUTO, COOL, DRY, FAN, HEAT.
3. Press "+" or "-" button to set your required temperature. (Temperature can't be adjusted under auto mode).
4. Press "FAN" button to set your required fan speed: auto, low, medium and high speed.

Replacement of batteries in remote controller

1. Press the mark “” on back cover of batteries box cover for remote controller with fingers as shown in the fig, and then remove the batteries box cover along the arrow direction.
2. Replace with two #7 (AAA 1.5V) dry batteries. Make sure positions for “+” pole and “-” pole are correct.
3. Reinstall batteries box cover.

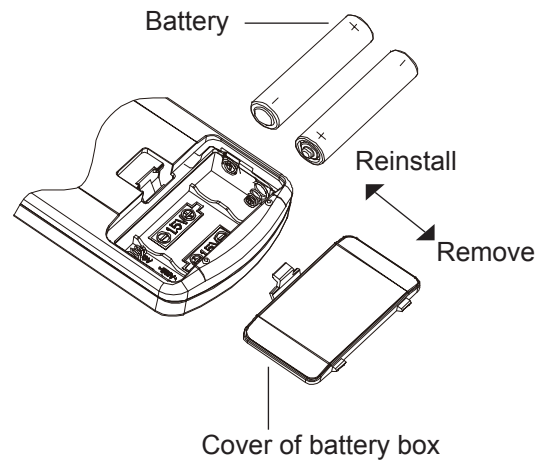

NOTICE

- The distance between signal transmitter and receiver window should be less than 8m, and there should be no obstacles between them.
- As the signal will be interfered in the room with electronic fluorescent lamp, conversion fluorescent lamp or wireless phone, please get closer to the air conditioner when using the remote controller.
- Replace new batteries of the same model when replacement is required.
- When you don't use remote controller for a long time, please take out the batteries.

Remote control panel

Note:

- If wireless remote controller is lost, you can use the remote control panel and operate manually.
- The schematic diagram of membrane in the instruction manual is only for reference. Please refer to the actual product.

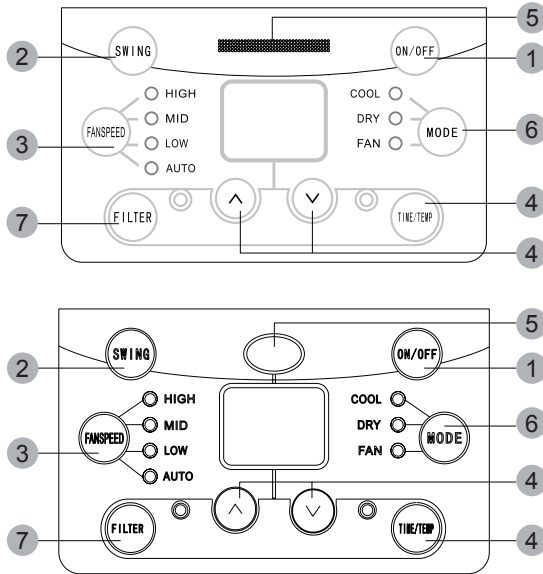

1 ON/OFF BUTTON

Operation starts when pressing this button, and stops when pressing this button again.

2 SWING BUTTON

Activate the automatic air swing function.

3 FAN SPEED BUTTON

Select the fan speed LOW, MID, HIGH and AUTO in sequence.

4 TIME/TEMP BUTTON

Press the \wedge keypad to increase the set (operating) temperature of the unit. and Press the \vee keypad to decrease the set (operating) temperature of the unit. The temperature setting range is from 16~30°C. Press the \wedge keypad also to increase the selected time in 0.5 hour increments, and Press the \vee keypad to decrease the selected time in 0.5 hour decrements, The time setting range is from 0~10 hours. Press the \wedge keypad also to increase the selected time in 1 hour increments, and Press the \vee keypad to decrease the selected time in 1 hour decrements, The time setting range is from 10~24 hours.

When press the TIME/TEMP button, the LED (lamp) will blink. Within LED is blinking, set the time by using the \wedge \vee keypad. After 5 seconds, the timer will be confirmed and the LED will turn on. During unit operation, the display returns to the setting temperature. During unit stopped, the time display turns off.

If want to cancel the setting timer, press the TIME/TEMP button and within LED is blinking, press the TIME/TEMP button again. LED will turn off.

5 SIGNAL RECEIVER

6 MODE BUTTON

Select the operation mode, COOL, DRY, FAN, HEAT (for reverse cycle model) or COOL, DRY, FAN (for cooling only model).

7 FILTER BUTTON

This feature is a reminder to clean the Air Filter (See Care and Cleaning) for more efficient operation and cooling. The LED (light) will illuminate after 250 hours of operation. To reset after cleaning the filter, press the "Check Filter" button and the light will go off. Before the LED(light) illuminate, press the "Check filter" button until after 3 seconds, the accumulated time of operation will be canceled.

8 MEMORY FUNCTION

This product has a memory function, so if unplug from power supply or the power is interrupted due to a power failure while unit is operating, operation will resume when the power supply is resumed.

Regardless of whether the unit is running or stopped, the timer function is stored in memory and will resumed when the power supply is restored.

● Operation Tips

Operation for comfort and economy

Do not overcool the room temperature. This is not good for health and wastes electricity.

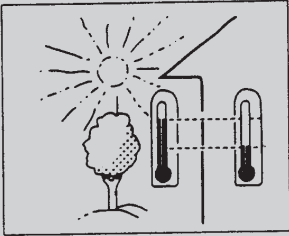

Keep blind or curtains closed. Do not let sunshine enter the room directly when the air conditioner is in operation.

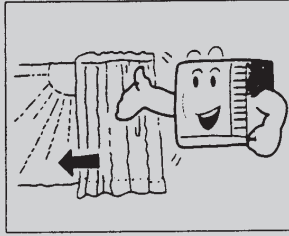

Keep the room temp. uniform. Adjust the vertical and horizontal airflow direction to ensure a uniform temperature in the room. Air can't be discharged to the direction of air-in.

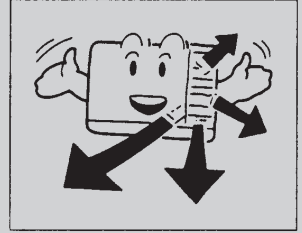

Make sure that the doors and windows are tightly closed. Avoid opening doors and windows as much as possible to keep air conditioning in the room.

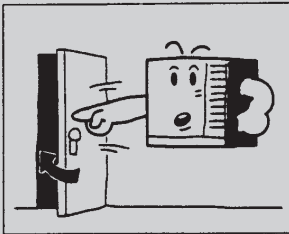

Clean the air filter regularly. Blockages in the air filter reduce dehumidifying effects. Clean the air filter at least once every two weeks.

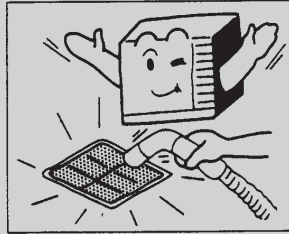

Ventilate the room occasionally. Since windows are kept closed, it is a good idea to open them and ventilate the room now and then. When starting the unit, curtains or windows should be closed to prevent the heat/cool leakage.

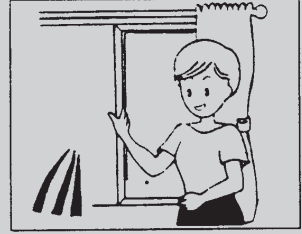

● Caution

Operations for safety and health

- 1) The plug must be accessible after the appliance is positioned.
- 2) Do not use this appliance in the laundry.
- 3) If the power cord is damaged, it must be replaced by the manufacture or its service agent in void of hazard.

- Do not pull out the power cord.
- Damage to the cord may result in serious electric shocks

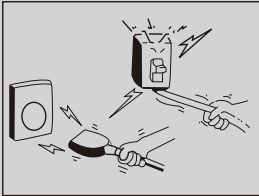

- Do not use the air conditioner for other purposes except for cooling the room.
- Do not use the air conditioner for other purposes such as drying clothes, preserving foods, or cultivating vegetables.



- Do not block the air intake and outlet vents. This causes lowered performance and irregular operation.
- Do not insert sticks or other objects into these vents as it is dangerous to touch the electric components and the fan.



Select the most appropriate temperature. Pay attention to adjust the temperature to suit the conditions. Rooms occupied by infants, the elderly, or the sick should be kept at an appropriate temperature.

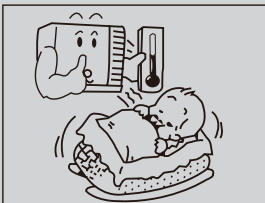

Do not use heating apparatuses in the vicinity. The air conditioner's plastic parts will melt if exposed to excessive heat.

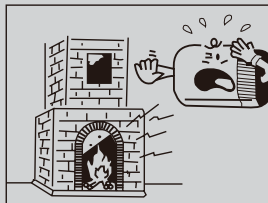

Avoid exposing the body directly to a continuous unidirectional air flow for long periods. This is not recommended for health reasons.

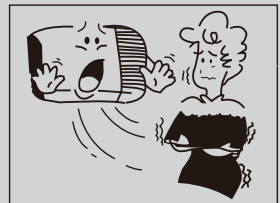

Always wait at least 3 minutes before switching the air conditioner on again after you have switched it off during cooling or heating.



Please notice that the unit is filled with mildly flammable refrigerant R32.

Inappropriate treatment of the unit involves the risk of severe damages of people and material. Details to this refrigerant are found in chapter "refrigerant".

The appliance is using mildly flammable refrigerant R32 and tested to comply with IEC 60335-2-40. There is no minimum room area requirement for the appliance.

Care and maintenance

Always turn off the air conditioner and main power supply before cleaning to ensure safety.

Cleaning unit

1. Cut power off before cleaning.

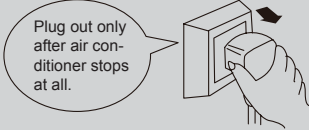

2. Use soft cloth when cleaning cabinet. If the cabinet is very dirty, dip cloth into warm water below 40°C, dry the cloth and then rub off the dirt.



3. Don't use gas, benzene, solvent, wash, chemical solvent, etc. for cleaning.



4. Do not splash water directly into the unit, in which there are micro-computer and circuit plate, they must not be drenched with water.



- * Check earth wire



Air filter

The air filter behind the intake grille should be washed at least once every two weeks or as often as it needs cleaning.

How to clean the air filter:

1. To remove the air intake grille, grasp the tab on the filter and pull to take out.

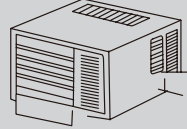

2. Vacuum the filter on the dusty side to remove light dust.

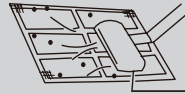

Vacuum cleaner

3. Wash the filter, cleaner side up under gently flowing water to wash out accumulated dust and lint.



4. If the filter is very dirty, use a mild household detergent in the wash water.



Let the filter dry thoroughly before reinstalling it. If necessary, please ask the professional personnel to clean it.



- * Check if air inlet and outlet of the unit blocked or not.

Air lock could result in bad efficiency.

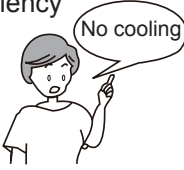

● Troubleshooting guide

Please check the following items before asking for repair, it saves your time and money.

Fault phenomenon	Trouble-shooting
<p>Air conditioner does not operate at all.</p> 	<ul style="list-style-type: none"> • Is there a power failure? • Is the plug out? • Is power fuse or switch off ? • Whether the voltage is too high or too low?
<p>Cool or heat efficiency is not good.</p> 	<ul style="list-style-type: none"> • Is air inlet or outlet locking? • Is there any other heat /cool source in room? • Are air filters dirty very much? • Is indoor fan speed set at LOW? • Maybe the room is too hot/cool when the unit is started.
<p>Foggy air flows out.</p> 	<ul style="list-style-type: none"> • At COOL mode operation, sometimes there is foggy air flowing out of the unit, this is because the room humid air has been cooling rapidly. • The unit is normal while the indoor outlet is sending out some odor, because the inlet air may be mixed with the smell of furniture and smoke.
<p>The air conditioner operation is noisy.</p> 	<ul style="list-style-type: none"> • For a noise that sounds like water flowing: This is the sound of freon flowing inside the air conditioner unit. • For a noise that sounds like a shower: This is the sound of the dehumidifying water being processed inside the air conditioner unit.
<p>It seems that condensation is leaking from air conditioner.</p>	<ul style="list-style-type: none"> • Condensation occurs when the airflow from the air conditioner cools the warm room air.
<p>Air conditioner does not operate for about 3 minutes when restart.</p>	<ul style="list-style-type: none"> • This is to protect the mechanism. • Wait about three minutes and operation will begin.

Malfunction code	Solution
H5	Please contact professional person to deal with it.
E5	Please contact professional person to deal with it.
E4	Please contact professional person to deal with it.
H3	Please contact professional person to deal with it.
H5	Please contact professional person to deal with it.
PL	Please contact professional person to deal with it.
PH	Please contact professional person to deal with it.
HC	Please contact professional person to deal with it.
Fo	Please contact professional person to deal with it.
F3	Please contact professional person to deal with it.
F4	Please contact professional person to deal with it.
F5	Please contact professional person to deal with it.
F0	Please contact professional person to deal with it.
E6	Please contact professional person to deal with it.
F1	Please contact professional person to deal with it.
F2	Please contact professional person to deal with it.
U7	Please contact professional person to deal with it.

Note: If there're other malfunction codes, please contact qualified professionals for service.

Immediately stop all operations and plug out, please contact your dealer in the following situations.

- * Operation starts or stops abnormally;
- * Power fuse or switch often breaks;
- * Carelessly splash water or something into air conditioner;
- * Electrical lines are much hot or lines cover breaks;
- * Other strange situations.



● Others

- The connection between AC and power cord or among other elements independently shall be subject to wiring diagram on the unit.
- Model and rated value of fuse shall be subject to screen print on corresponding controller or protective bushing.

● After service

- If your air conditioner has some questions of quality or anything else, please contact the service center.

● Safety operation of flammable refrigerant

● Qualification requirement for installation and maintenance man

1. All the work men who are engaging in the refrigeration system should bear the valid certification awarded by the authoritative organization and the qualification for dealing with the refrigeration system recognized by this industry. If it needs other technician to maintain and repair the appliance, they should be supervised by the person who bears the qualification for using the flammable refrigerant.
2. It can only be repaired by the method suggested by the equipment's manufacturer.

● Installation notes

1. The air conditioner is not allowed to use in a room that has running fire (such as fire source, working coal gas ware, operating heater).
2. The appliance is using mildly flammable refrigerant R32 and tested to comply with IEC 60335-2-40.
There is no minimum room area requirement for the appliance.
The minimum installation height of this appliance is 1000mm.
3. Leak test is a must after installation.

● Maintenance notes

1. Check whether the maintenance area or the room area meet the requirement of the nameplate.
 - It's only allowed to be operated in the rooms that meet the requirement of the nameplate.
2. Check whether the maintenance area is well-ventilated.
 - The continuous ventilation status should be kept during the operation process.
3. Check whether there is fire source or potential fire source in the maintenance area.
4. Check whether the appliance mark is in good condition.
 - Replace the vague or damaged warning mark.

● **Welding**

1. If you should cut or weld the refrigerant system pipes in the process of maintenance, please follow the steps as below
 - a. Shut down the unit and cut power supply
 - b. eliminate the refrigerant
 - c. vacuuming
 - d. clean it with N₂ gas
 - e. cutting or welding
 - f. carry back to the service spot for welding
2. The refrigerant should be recycled into the specialized storage tank.
3. Make sure that there isn't any naked flame near the outlet of the vacuum pump and it's well-ventilated.

● **Filling the refrigerant**

1. Use the refrigerant filling appliances specialized for R32. Make sure that different kinds of refrigerant won't contaminate with each other.
2. The refrigerant tank should be kept upright at the time of filling refrigerant.
3. Stick the label on the system after filling is finished (or haven't finished)
4. Don't overfilling.
5. After filling is finished, please do the leakage detection before test running; another time of leak detection should be done when it's removed.

● **Safety instructions for transportation and storage**

1. Please use the flammable gas detector to check before unload and open the container.
2. No fire source and smoking.
3. According to the local rules and laws.

目錄

感謝您選擇本冷氣機。我們的設計基於效率最佳和噪音最低的運行理念，可以保持房間的舒適度。在操作本機組之前，請仔細閱讀此說明書，閱讀後，請妥善保存此說明書，以便日後翻閱。

結構機理和安裝

製冷劑	1
維修專員手冊	2
安全注意事項	8
功能	9
電源要求	10
安裝	11
安裝注意事項	14

操作程序

零件標識	15
風向調整	15
遙控操作程序遠程	16
控制面板	21
操作提示	23

保養與維護

注意事項	24
保養與維護	26
故障排除指南	27
售後服務	28
易燃製冷劑的安全操作	29

操作本機組前，請仔細閱讀本說明書。



警告: 加注了輕度易燃製冷劑R32的設備。如果製冷劑洩漏並暴露於外部火源，則有著火的風險。



小心: 在使用設備之前，請先閱讀說明書。



小心: 在安裝設備之前，請先閱讀說明書。



小心: 維修設備之前，請先閱讀說明書。

本手冊中的圖片可能與實物有所不同，請以實物為準。

符號說明



危險

表示如不避免，則會造成人員死亡或嚴重受傷的危險情況。



警告

表示如不避免，則可能造成人員死亡或嚴重受傷的危險情況。



小心

表示如不避免，則可能導致輕傷或中度傷害的危險情況。

注意

表示重要但與危險無關的信息，用於表示財產損失風險。



表示將被分配信號詞「警告」或「小心」的危險。

例外條款

當以下原因導致人身傷害或財物損失時，製造商將不承擔任何責任。

1. 因產品使用不當或誤用而損壞產品；
2. 在不遵守製造商的說明書的情況下，對產品進行改動、更改、維護或與其他設備一起使用；
3. 經核實，產品的缺陷是由腐蝕性氣體直接引起的；
4. 經核實，缺陷是由於產品運輸過程中操作不當造成的；
5. 在不遵守說明書或相關規定的情況下操作、修理、維護機組；
6. 經核實，問題或爭議是由其他製造商生產的零部件的質量規範或性能引起的；
7. 損壞是由自然災害、惡劣的使用環境或不可抗力造成的。

如需要安裝、移動或維修冷氣機，請先聯絡經銷商或當地服務中心。冷氣機必須由指定單位進行安裝、移動或維修。否則，可能會導致嚴重損壞、人身傷害或死亡。

當製冷劑在安裝、維護或拆卸過程中泄漏或需要排放時，應由經過認證的專業人員進行處理，或按照當地法律法規進行處理。

● 製冷劑

- 為了實現冷氣機機組的功能，一種特殊的製冷劑在系統中循環。使用的製冷劑是R32。製冷劑輕度易燃且無氣味。此外，在某些條件下，製冷劑可能會導致爆炸。但製冷劑的可燃性非常低。其只能被火點燃。
- 與普通製冷劑相比，R32是一種對臭氧層無害的無污染製冷劑。其對溫室效應的影響也較低。R32具有非常好的熱力學特性，這使其具有非常高的能量效率。因此，這些機組需要的加註量較少。

警告：

除製造商建議的方法外，請勿使用其他方法加速除霜過程或進行清洗。如果需要修理，請聯繫最近的授權服務中心。

應由專業人員進行安裝工作。由不合格的人員進行的任何修理都可能帶來危險。設備應存放在沒有連續運行的點火源的房間內（例如：明火、正在運行的燃氣設備或正在運行的電制熱器）。

請勿穿孔或燒傷。

本設備使用輕度易燃的製冷劑R32，並按照IEC 60335-2-40進行了測試。本設備在使用時沒有最低房間面積要求。

本設備的最低安裝高度為1000mm。

加註了輕度易燃製冷劑R32的設備。修理時，應嚴格遵循製造商的說明。

請注意，製冷劑可能沒有氣味。

閱讀專業手冊。



8歲或以上的兒童，以及身體、感官或智力有缺陷或缺乏經驗和知識的人士，只要有監督或指導，採用安全的使用方式，並瞭解本設備的危險，均可使用本設備。

請勿讓兒童玩耍本設備。

請勿讓兒童在無人看管的情況下清洗和維護本設備。

● 維修專員手冊

● 以下檢查應適用於使用易燃製冷劑的設備：

- 加註量是否與裝有製冷劑的部件的空間大小一致；
- 通風機械和出氣口是否充分運行，不受阻礙；
- 如果使用間接製冷迴路，應檢查二次迴路中是否存在製冷劑；
- 設備上的標記是否仍然清晰可見。應糾正模糊不清的標識和標誌；
- 除非部件由本身耐腐蝕或適當防腐蝕的材料製成，否則，製冷管或部件的安裝位置應不會接觸任何可能腐蝕含製冷劑的部件的物質。

● 區域檢查

開始在含有易燃製冷劑的系統上作業之前，必須進行安全檢查，以確保最大限度地降低引燃風險。對於製冷系統的修理，在對系統進行作業之前，應完成 IEC60335-2-40:2018附錄DD.4.3至DD.4.7的內容。

● 工作程序

操作應在受控程序下進行，以儘量減少在作業期間出現易燃氣體或蒸氣的風險。

● 一般工作區域

應向所有維護人員和附近區域工作的其他人員說明正在進行的工作性質。應避免在密閉空間內工作。

● 維修專員手冊

● 檢查製冷劑的存在

在工作之前和工作期間，應使用適當的製冷劑檢測器檢查該區域，以確保技術人員瞭解潛在的有毒或易燃環境。確保使用的洩漏檢測設備適合與適用的製冷劑一起使用，即不產生火花、充分密封或本質安全。

● 提供滅火器

如有任何冷凍設備或任何相關部分要進行任何熱功作業，應有適當的滅火設備可供使用。加註區域旁應備有干粉或二氧化碳滅火器。

● 無火源

任何人在進行涉及暴露任何管道工程的製冷系統相關施工時，不得以可能導致火災或爆炸風險的方式使用任何火源。所有可能的火源（包括吸煙）都應遠離安裝、修理、拆遷和處置場所，因為在此期間易燃製冷劑可能會釋放到周圍空間。在施工之前，應對設備周圍區域進行檢查，以確保沒有易燃危險或着火風險。應設置『禁止吸煙』標誌。

● 通風區域

在拆卸系統或進行任何熱功作業之前，確保該區域為開放狀態或通風良好。在作業期間，應保持通風。通風應安全地消散任何釋放的製冷劑，並最好將其排放到大氣中。

● 檢查製冷設備

如果更換電氣部件，則部件應符合用途和正確的規格。在任何時候都應遵循製造商的維護和檢修指南。如有疑問，請諮詢製造商的技術部門以獲取幫助。

以下檢查應適用於使用易燃製冷劑的設備：

- 加註量是否與裝有製冷劑的部件的空間大小一致；
- 通風機械和出氣口是否充分運行，不受阻礙；
- 如果使用間接製冷迴路，應檢查二次迴路中是否存在製冷劑；
- 設備上的標記是否仍然清晰可見。應糾正模糊不清的標識和標誌；
- 除非部件由本身耐腐蝕或適當防腐蝕的材料製成，否則，製冷管或部件的安裝位置應不會接觸任何可能腐蝕含製冷劑的部件的物質。

● 維修專員手冊

● 檢查電氣設備

電氣部件的修理和保養應包括初始安全檢查和部件檢查程序。如果存在可能危及安全的故障，則在可靠處理之前，不得將電源連接到電路。如果故障無法立即排除但需要繼續運作，則應使用適當的臨時解決方案。該情況應報告給設備的所有者，以便告知各方。

初始安全檢查應包括：

- 電容器放電：應以安全的方式進行，以避免產生火花；
- 在加注、回收或清洗系統期間，應確保冷氣系統中無暴露的帶電電氣元件和電線。
- 連續屏蔽接地。

● 修理密封元件

在密封元件的修理過程中，所有電源應在拆除密封蓋等之前與設備斷開。如果維修期間必須為設備供電，則應在最關鍵的位置設置永久性檢漏操作表，以警告潛在的危險情況。

應特別注意以下事項，以確保通過對電氣部件進行操作，不會改變外殼，以免影響防護等級。這應包括電纜損壞、連接數量過多、未達到原始規格的端子、密封件損壞、密封套安裝不正確等。

- 確保設備安裝牢固。
- 確保密封件或密封材料未劣化至使其無法再用於防止易燃物進入。更換零件應符合製造商的規格。

注意：使用硅密封劑可能會影響某些類型的檢漏設備的有效性。在處理本質安全部件之前，不必將其隔離。

● 修理防爆元件

在未確保不會超過所用設備的容許電壓和電流的情況下，請勿對電路施加任何永久性電感或電容負載。

防爆元件是唯一可以在易燃環境中對其進行作業的部件。試驗裝置的額定值應正確。

應僅使用製造商指定的更換部件。其他零件可能會導致製冷劑在大氣中因泄漏而着火。

● 電纜佈線

檢查電纜是否會受到磨損、腐蝕、過度壓力、振動、接觸鋒利邊緣或任何其他不利環境影響。檢查還應考慮到老化或來自諸如壓縮機或風扇等來源的持續振動的影響。

● 洩漏檢測方法

洩漏檢測液體適用於大多數製冷劑，但應避免使用含氯洗滌劑，因為氯可能與製冷劑發生反應並腐蝕銅管道。

● 維修專員手冊

● 檢測易燃製冷劑

在任何情況下都不得使用潛在的點火源來尋找或檢測製冷劑泄漏。不得使用鹵素檢漏燈（或使用明火的任何其他檢測器）。

以下泄漏檢測方法被認為可用於所有製冷劑系統。

電子泄漏檢測器可用於檢測製冷劑泄漏，但在易燃製冷劑的情況下，靈敏度可能不夠，或者可能需要重新校準。（檢測設備應在無製冷劑區域進行校準。）確保檢測器不是潛在的點火源，且適用於所用的製冷劑。泄漏檢測設備應按製冷劑LFL的百分比設定，並應根據所用製冷劑進行校準，並確認適當的氣體百分比（最大25%）。泄漏檢測流體適用於大多數製冷劑，但應避免使用含氯洗滌劑，因為氯可能與製冷劑發生反應並腐蝕銅管道。

注意：檢漏液的例子有

- 氣泡法，
- 熒光試劑法。

如果懷疑泄漏，應清除/撲滅所有明火。

如果發現有製冷劑泄漏且需要鈎焊，則應從系統中回收所有製冷劑，或將其隔離在系統中遠離泄漏處的部分（通過截止閥）。製冷劑的去除應符合《清除和排空》條款的規定。

● 清除和排空

當拆開製冷劑迴路進行修理或進行任何其他作業時，應使用常規程序。然而，對於易燃製冷劑，重要的是要遵循最佳實踐，因為易燃性是一個考慮因素。應遵循以下程序：

- 去除製冷劑；
- 用惰性氣體吹掃迴路；
- 清除；
- 用惰性氣體吹掃；
- 通過切割或鈎焊打開回路。

製冷劑應回收到正確的回收鋼瓶中。對於含有易燃製冷劑的設備，系統應使用無氧氮氣吹掃，以確保設備對易燃製冷劑安全。此過程可能需要重複數次。壓縮空氣或氧氣不得用於清洗製冷劑系統。

對於含有易燃製冷劑的設備，製冷劑吹掃應通過用無氧氮氣打破系統中的真空並繼續加註直至達到工作壓力，然後排放至大氣，最後抽至真空來實現。應重複此過程，直到系統內沒有製冷劑。當使用最後的無氧氮氣加註時，系統應排空至大氣壓力，以便能夠進行工作。如果要對管道進行鈎焊，則上述工作至關重要。

● 維修專員手冊

確保真空泵的出氣口不靠近任何潛在火源並且配有通風裝置。

● 加註程序

除傳統的加註程序外，還應遵循以下要求：

- 使用加註設備時，確保不會發生不同製冷劑的污染。軟管或管線應儘可能短，以儘量減少其中所含的製冷劑量。
- 應根據說明將鋼瓶保持在適當的位置。
- 在向系統加註製冷劑之前，確保製冷系統接地。
- 加註完成後標記系統（如果尚未標記）。
- 應特別注意勿使製冷系統滿溢。
在對系統進行再加註之前，應使用適當的吹掃氣體對其進行壓力測試。完成加註後，應在調試之前對系統進行泄漏測試。在離開現場之前，應進行後續泄漏測試。

● 停用

在執行此程序之前，技術人員必須完全熟悉設備及其所有細節。建議的良好做法是安全回收所有製冷劑。在執行任務之前，應採集油和製冷劑樣本，以備在重新使用回收的製冷劑之前需要進行分析時使用。在任務開始之前，必須有可用電源。

- a) 熟悉設備及其操作。
- b) 將系統電氣隔離。
- c) 在嘗試該程序之前，應確保：
 - 如果需要，可提供機械搬運設備，用於搬運製冷劑鋼瓶；
 - 備有所有個人防護裝備並正確使用；
 - 回收過程由合格人員隨時監督；
 - 回收設備和鋼瓶符合適當的標準。
- d) 如果可能的話，抽空製冷系統。
- e) 如果無法達到真空，則製作分歧器，以便可以從系統的各個部分清除製冷劑。
- f) 在回收之前，確保鋼瓶位於秤上。
- g) 啓動回收機器並按照製造商的說明操作。
- h) 請勿使鋼瓶滿溢。（液體加註量不超過80%（體積比））。
- i) 請勿超過鋼瓶的最大工作壓力，即使是暫時。
- j) 如果鋼瓶已正確加註並且已完成，應確保立即從現場移除鋼瓶和設備，並關閉設備上的所有隔離閥。

● 維修專員手冊

k) 除非經過淨化和檢查，否則，不得將回收的製冷劑裝入另一個製冷系統。

● 貼標

設備應貼上標籤，說明設備已停用並排空製冷劑。標籤應註明日期並簽字。對於含有易燃製冷劑的設備，確保設備上有標籤，說明設備含有易燃製冷劑。

● 回收

從系統中清除製冷劑（維修或停用）時，建議將所有製冷劑安全清除。

將製冷劑轉移到鋼瓶中時，請確保只使用合適的製冷劑回收鋼瓶。確保可以使用正確數量的氣瓶來回收系統的所有製冷劑。所有使用的鋼瓶都指定用於回收的製冷劑，並用標籤標明該製冷劑（即用於回收製冷劑的專用鋼瓶）。鋼瓶應配有泄壓閥和相關切斷閥，且工況良好。將空的回收鋼瓶排空，並且如果可能的話，在回收之前冷卻。回收設備應處於良好的工作狀態，並配有一套關於現有設備的說明，且適用於回收所有適當的製冷劑，包括易燃製冷劑（如適用）。此外，還應提供一套經過校準的計重秤，計重秤應工況良好。軟管應配備無泄漏的可卸接頭並且工況良好。在使用回收機器之前，檢查其工況是否合格，是否已正確維護以及是否密封了所有相關的電氣部件，以防止在製冷劑釋放時引燃。如有疑問請諮詢製造商。

回收的製冷劑應使用正確的回收鋼瓶返還製冷劑供應商，並提供相關的廢物轉移說明。切勿將製冷劑混裝在回收設備中，尤其不能混裝在鋼瓶中。

如果要移除壓縮機或壓縮機機油，請確保將壓縮機排空到可接受的水平，以確保易燃製冷劑不會殘留在潤滑油中。應在將壓縮機送回供應商之前進行排空。只能採用對壓縮機機體進行電加熱來加快排空過程。當從系統中排出機油時，應安全地進行排放。

● 安全注意事項

⚠ 警告

8歲或以上的兒童，以及身體、感官或智力有缺陷或缺乏經驗和知識的人士，只要有監督或指導，採用安全的使用方式，並瞭解本設備的危險，均可使用本設備。

請勿讓兒童玩耍本設備。

請勿讓兒童在無人看管的情況下清洗和維護本設備。

冷氣機的安裝應符合國家接線法規。

冷氣機應正確接地。不正確的接地可能導致觸電。

- 請勿將冷氣機連接到多用途插座上。否則，可能會引發火災。
- 務必安裝空氣開關。否則，可能會導致故障。
- 請勿將水灑在遙控器上，否則可能會損壞遙控器。
- 請勿在冷氣機上噴水。這可能會導致觸電或故障。
- 請勿將手指或物體伸入進氣口或出氣口。這可能會造成人身傷害或損壞。
- 請勿踩踏冷氣機，也不要放重物。這可能會造成損壞或人身傷害。
- 請勿堵塞出氣口或進氣口。這可能會導致故障。
- 清洗冷氣機時務必斷開電源。否則，可能會導致觸電。
- 請勿自己修理冷氣機。這可能會導致觸電或損壞。當需要修理冷氣機時，請聯繫經銷商。
- 必須由合格的專業人員進行維護。否則，可能會造成人身傷害或損壞。
- 除非得到監督或指導，否則不允許肢體殘疾、感官或智力不良者或缺乏經驗和知識者（包括兒童）使用本設備。
- 應監督兒童不玩耍本設備。

安裝冷氣機時，請安裝短路保護和漏電保護裝置。

根據當地安全法規，使用合格的電源電路和斷路器。

工作溫度範圍

※ 工作溫度範圍		
	室內側DB/WB (°C)	室外側DB/WB (°C)
最大製冷量	32/23	43/-

僅製冷機組的工作溫度範圍（室外溫度）為18°C~43°C。

● 功能

介紹

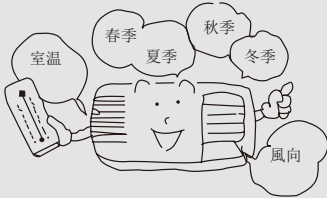

窗口式室內冷氣機可以調節室溫，並使室內乾燥。其能夠方便工作、學習和生活。其可以廣泛應用於住宅、商店、酒店、辦公室、圖書館和實驗室等。

夏季製冷

在炎熱的夏季，冷氣機可以通過向外傳遞熱量來冷卻室內空氣。

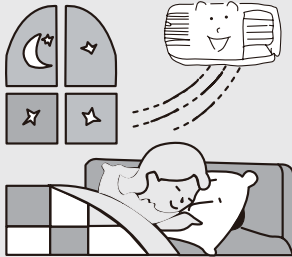

雨季或潮濕季節除濕

在不降低室內溫度的情況下，冷氣機可以除濕，使室內空氣乾燥舒適。



● 運行條件

- 請在以下適當條件下運行冷氣機。

『製冷』模式運行	『乾燥』模式運行
室外溫度應在18°C到43°C之間，否則冷氣機可能會損壞。室內濕度應低於90%。否則，冷氣機在長時間運行後，可能會在冷氣機表面結露，甚至滴水。但這很正常。	室外溫度應在18°C到43°C之間，否則冷氣機可能會損壞。

電源要求



- * 電壓過高會損壞電氣部件。如果電壓過低，則壓縮機將劇烈振動，損壞製冷劑系統，並容易導致壓縮機和電氣部件無法工作。

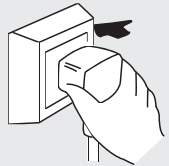

- 必須接地。
- * 必須使用專用插座。此外，插座和接線必須符合接線規定。接地方式必須可靠。
- * 在固定電路中，必須有足夠功率容量的漏電保護開關和足夠空間的空氣開關。



接地線

為確保可靠接地，請勿將接地線連接到以下位置：

水管

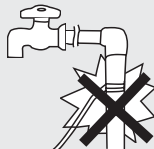

● 安裝

安裝注意事項：

窗口式冷氣機非常貴重，安裝不當會造成很大的損壞！請聯繫專業技術人員安裝，勿自己安裝。否則，我們不對因此造成的損失負責。



位置：

- 本設備的最低安裝高度為1000mm。
- 冷凝水必須能夠方便地排出。
- 冷氣機機組應安裝在遠離電視機或收音機等的位置，以免干擾視頻或語音。
- 在含鹽和沿海地區或靠近溫泉並被含硫氣體污染的地方，或其他特殊地區，請在使用前與賣方聯繫。
- 避開易燃氣體可能洩漏的地方。
- 避免其他熱源或陽光直射。
- 避開兒童容易接觸的地方。
- 請勿在洗衣房、浴缸、淋浴間或游泳池附近使用本機組。
- 對於帶遙控器的窗口式冷氣機，如果將其安裝在電磁干擾強的地方，應提前與賣方聯繫，避免在使用中出現故障。

如何安裝：

- 選擇一個機組周圍沒有任何障礙物，且可以接近插頭的位置。
- 準備稍大於機組尺寸的安裝孔。
- 根據下圖選擇安裝空間。

冷氣機與周圍障礙物的距離應滿足以下要求：300 mm以上（上面）、500 mm以上（左側）、500 mm（右側）、1500 mm以上（前面）和500 mm以上（後面）。

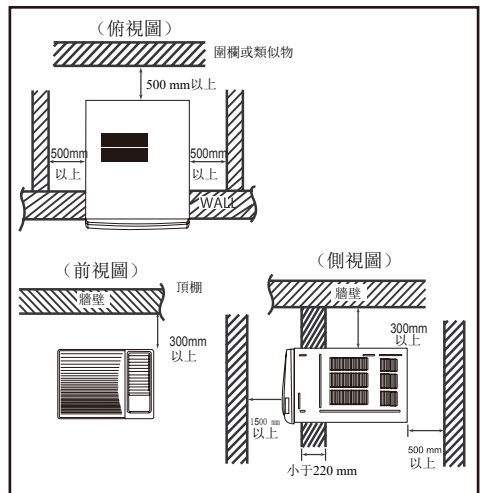

安裝程序：

- 1) 取下前面板上的粘貼標籤。
- 2) 將機組放入安裝孔中。
 - 安裝機組時，應將其向後傾斜，以避免噪聲或振動增大。（傾斜6至10 mm。）（如右圖所示。）
 - 安裝位置應足夠堅固，以避免噪聲或振動增大。
- 3) 用海綿或泡棉填滿機櫃裏的縫線。

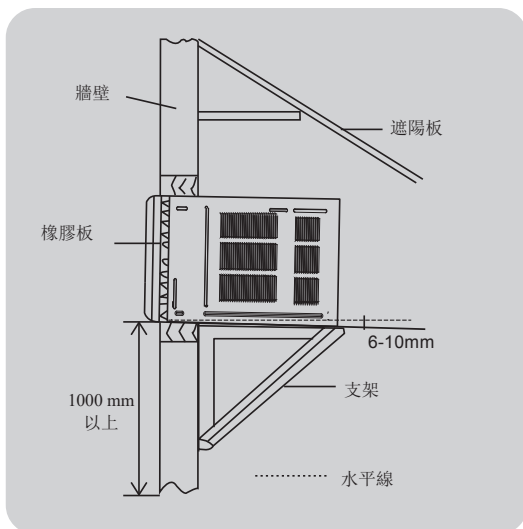

安裝要求：

- 使用鐵支架
安裝孔的強度應足以支撐冷氣機。如果不能，就必須在室外使用鐵支架。鐵支架應固定在建築物上（如右圖所示）
- 使用遮陽板
應該避免任何東西掉到冷氣機裏面，且應避免陽光直射。如果上面沒有遮蓋物，則應聯繫賣方安裝遮陽板。安裝遮陽板時，勿讓其擋住側格柵處的進氣口。

排水方法1:

為了獲得最大的製冷效率，冷氣機的設計是將冷凝水濺到冷凝器盤管上。

如果對濺水聲感到惱火，可以使用以下程序提供外部排水管，但這可能會導致性能小幅受損。

1. 機組後面有一個排水口。
2. 拆下排水口的蓋子，然後用螺釘將排水接頭連接到排水口上。
3. 將排水軟管連接到出口。

注意：

排水軟管或導管可在當地購買，以滿足特定需求。

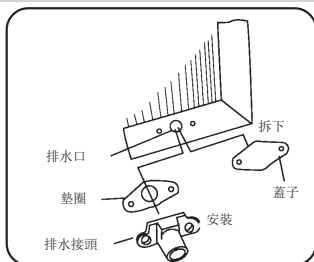

排水方法2:

為了獲得最大的製冷效率，冷氣機的設計是將冷凝水濺到冷凝器盤管上。

對於僅製冷的機組，如果對濺水聲感到惱火，可以使用以下程序提供外部排水，但這可能會導致性能小幅受損。

1. 從機櫃中滑出機箱。
2. 從箱體底板上拆下橡膠塞。
3. 用2個螺釘將排水盤安裝到機櫃的角落。
4. 將排水軟管連接到排水盤底部的出口上。
5. 將機箱滑入機櫃中的原始位置。

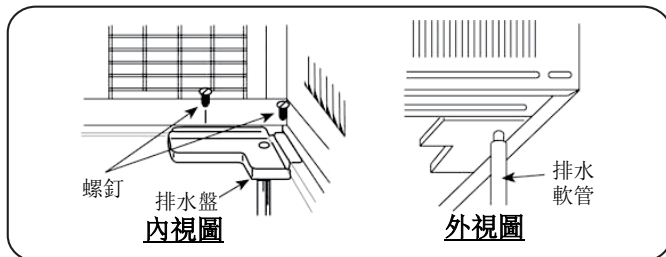

注意：

- 在使用逆向循環型號之前，必須安裝排水盤和排水軟管。
- 排水軟管或導管可在當地購買，以滿足特定需求。

● 安裝注意事項

拆下

在將冷氣機拆遷到其他地方之前，應首先聯繫賣方。

然後必須在專業技術人員的指導下進行拆遷。此外，還必須為此支付費用。

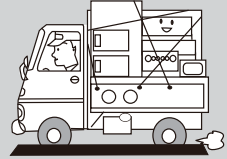

噪聲

- 安裝在足夠牢固的位置上，以避免噪聲和振動增大。
- 勿在機組出口前放置任何東西，以免增大噪聲。
- 確保熱空氣或噪聲不會給鄰居帶來不便。
- 操作過程中如有異常噪聲，請立即與賣方聯繫。
- 請使用安全支架。



電氣接線

- 必須可靠接地。
- 必須使用專用電路。但不能使用可移動插座，因為接觸不良會導致過熱或起火。
- 勿用力拉扯電源線。
- 在定電路中，必須有漏電電流小於30 mA的漏電保護開關。
- 冷氣機和電源線之間的連接方法，以及每個元件之間的互連方法均應符合機組上的接線圖。
- 冷氣機的安裝應符合國家接線法規。
- 全極斷開開關應採用固定接線，各極間觸點間距應不小於3 mm。
- 電路中應安裝空氣開關（熱磁斷路器），其容量為10 A（9 K 12K）/16 A（18 K）。
- 如果電源線損壞，必須由製造商、經銷商或合格人員進行更換，以避免危險。
- 所有電氣工作必須按照當地接線規定來完成。

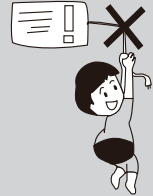

● 零件標識

面板外觀圖，僅供參考，請以機組實物為準。

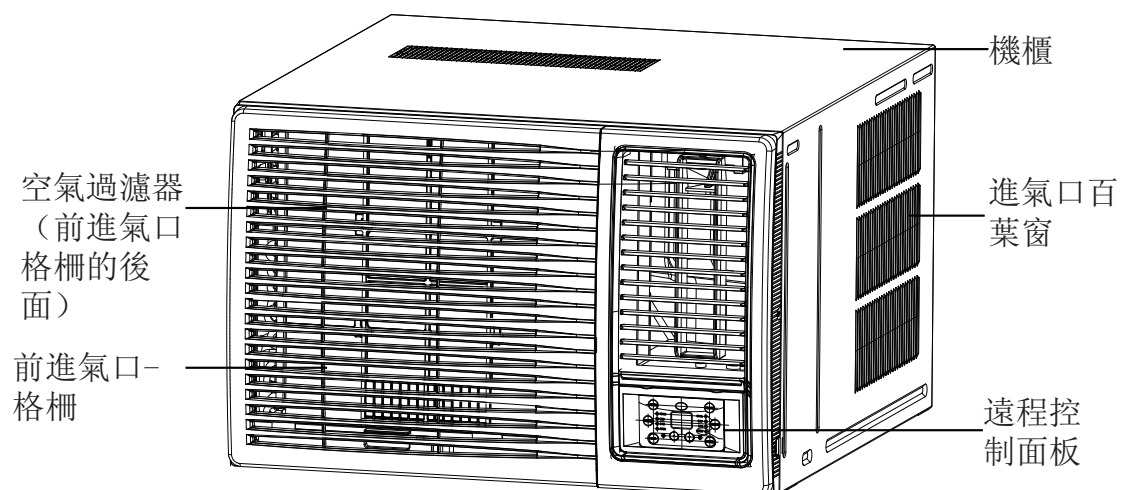

風向調整

垂直氣流方向葉片

(氣流方向上下調整)。

垂直氣流方向葉片通過定位葉片來予以控制，以便能夠向上、向下或直接向前排出空氣。



● 遙控操作程序

遙控器上的按鈕

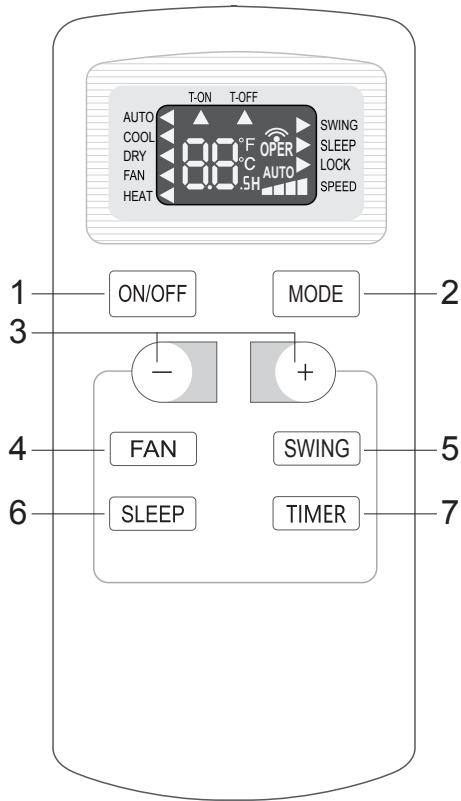

- ① 開/關按鈕
- ② 模式按鈕
- ③ +/- 按鈕
- ④ 風扇按鈕
- ⑤ 擺動按鈕
- ⑥ 睡眠按鈕
- ⑦ 定時器按鈕

顯示屏圖標介紹

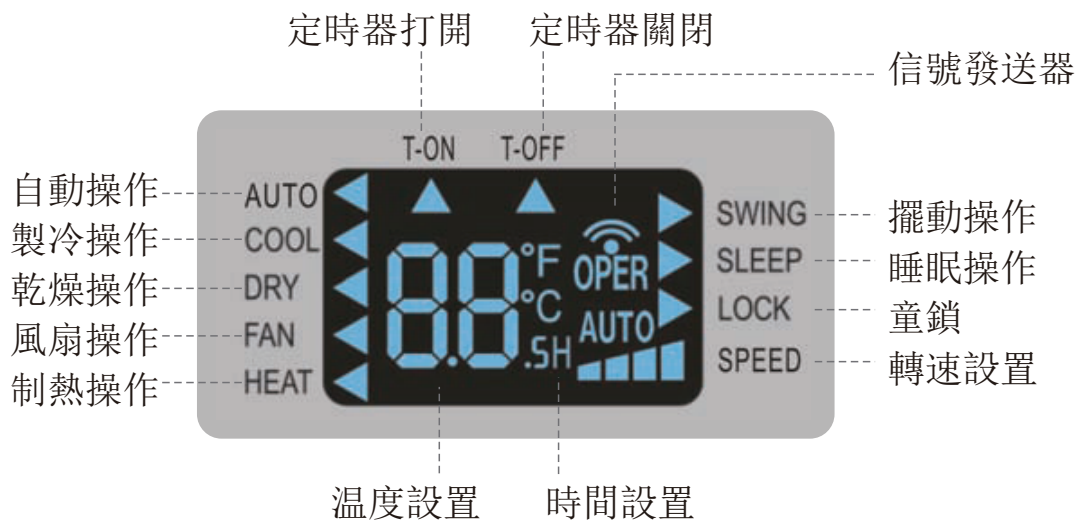

遙控器按鈕介紹

注意：

- 這是一款通用遙控器，可用於多功能冷氣機；對於某些型號沒有的功能，如果按下遙控器上相應的按鈕，則機組將保持原始運行狀態。
- 接通電源（待機狀態）後，可以通過遙控器操作冷氣機。
- 當機組打開時，每次按下遙控器上的按鈕，遙控器顯示屏上的發送信號圖標『📶』將閃爍一次。如果冷氣機發出嘟嘟聲，則表示信號已發出。
- 當機組關閉時，設置溫度將顯示在遙控器上（如果機組顯示器的燈打開，將顯示相應的圖標）；當機組打開時，它將顯示正在使用的功能的圖標。

1 開/關按鈕

按下此按鈕可打開/關閉機組。

2 模式按鈕

按下一次此按鈕可以循環選擇所需的模式，如下所示（選擇模式後，相應的圖標『◀』將點亮）：



- 當選擇自動模式時，冷氣機將根據環境溫度自動運行。設置溫度無法調整，也不會顯示。按下風扇按鈕可調整風扇轉速。
- 當選擇製冷模式時，冷氣機將在製冷模式下運行。然後可按『+』或『-』按鈕調整設置溫度。按下風扇按鈕可調整風扇轉速。
- 當選擇乾燥模式時，冷氣機將在乾燥模式下以低風扇轉速運行。在乾燥模式下，無法調整風扇轉速。
- 當選擇風扇模式時，冷氣機將僅在風扇模式下運行。然後按下風扇按鈕，以調整風扇轉速。
- 當選擇制熱模式時，冷氣機將在制熱模式下運行。然後可按『+』或『-』按鈕調整設置溫度。按下風扇按鈕可調整風扇轉速。（僅製冷的機組無法接收制熱模式信號。如果通過遙控器設置制熱模式，則按下開/關按鈕將無法打開冷氣機。）

3 +/--按鈕

- 按下『+』或『-』按鈕一次將使設置溫度升高或降低1°F（°C）。按住『+』或『-』按鈕2秒，遙控器上的設置溫度將迅速變化。達到所需的設置溫度後，鬆開按鈕。
- 當設置定時器開或定時器關時，按下『+』或『-』按鈕可調整時間。（有關設置的詳細信息，請參閱『定時器按鈕』部分）

遙控器按鈕介紹

4 風扇按鈕

按下此按鈕可循環選擇風扇轉速：自動、轉速1（▲）、轉速2（▲▲）、轉速3（▲▲▲）、轉速4（▲▲▲▲）（此冷氣機不可用。轉速4與轉速3相同。）。

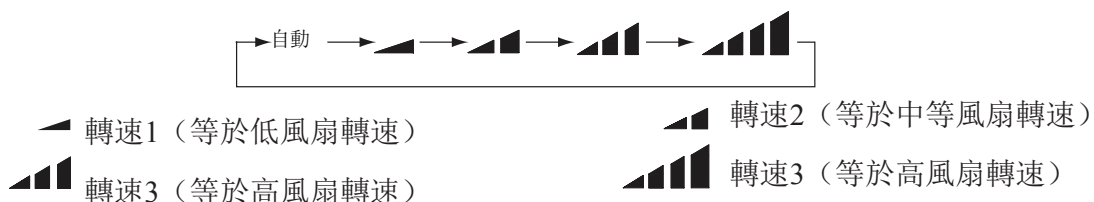

注意：

- 在自動轉速下，冷氣機會根據環境溫度自動選擇合適的風扇轉速。
- 在乾燥模式下無法調整風扇轉速。

5 擺動按鈕

按下此按鈕可打開左右擺風。

6 睡眠按鈕

在製冷、乾燥和制熱模式下，按下此按鈕可打開睡眠功能。按下此按鈕可取消睡眠功能。在風扇模式和自動模式下，此功能不可用。

7 定時器按鈕

- 當機組打開時，按下此按鈕可設置『定時器關』。T-OFF和H圖標將閃爍。在5秒內，按下『+』或『-』按鈕可調整『定時器關』的時間。按一次『+』或『-』按鈕將使時間增加或減少0.5小時。按住『+』或『-』按鈕2秒，時間會迅速變化。達到所需的設置時間後，鬆開按鈕。然後按下『定時器』按鈕進行確認。T-OFF和H圖標將停止閃爍。
- 當機組關閉時，按下此按鈕可設置『定時器開』。T-ON和H圖標將閃爍。在5秒內，按下『+』或『-』按鈕可調整『定時器開』的時間。按一次『+』或『-』按鈕將使時間增加或減少0.5小時。按住『+』或『-』按鈕2秒，時間會迅速變化。達到所需的設置時間後，鬆開按鈕。然後按下『定時器』按鈕進行確認。T-ON和H圖標將停止閃爍。
- 取消定時器開/關：如果設置了定時器功能，按一次『定時器』按鈕可查看剩餘時間。在5秒內，再次按下『定時器』按鈕可取消此功能。

遙控器按鈕介紹

注意：

- 時間設置範圍為：0.5~24小時。
- 兩次動作之間的時間不能超過5秒，否則，遙控器將退出設置狀態。

組合按鈕功能介紹

童鎖功能

同時按下『+』和『-』按鈕可以打開或關閉童鎖功能。當童鎖功能啓動時，遙控器上的“童鎖”指示燈點亮。如果操作遙控器，遙控器將不會發送信號。

溫度顯示切換功能

在斷電狀態下，同時按下『-』按鈕和『模式』按鈕可以在°C和°F之間切換。

燈光功能

在接通或斷開狀態下，可以同時按住『+』和『風扇』按鈕3秒鐘，使燈點亮或熄滅，併發送代碼。通電後，燈默認點亮。

操作指南

1. 接通電源後，按下遙控器上的開/關按鈕，打開冷氣機。
2. 按下模式按鈕，選擇所需模式：自動、製冷、乾燥、風扇、制熱。
3. 按『+』或『-』按鈕，設置所需的溫度。（自動模式下無法調整溫度）。
4. 按下風扇按鈕可設置所需的風扇轉速：自動、低速、中速和高速。

更換遙控器中的電芯

1. 如圖所示，用手指按壓遙控器電芯盒蓋後蓋上的『』標記，然後沿箭頭方向取下電芯盒蓋。
2. 更換兩節7號（AAA 1.5V）乾電芯。確保『+』極和『-』極的位置正確。
3. 重新安裝電芯盒蓋。

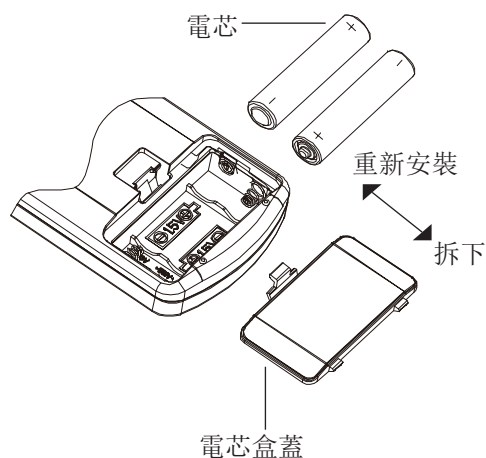

注意

- 信號發送器和接收器窗口之間的距離應小於8米，並且兩者之間不應有障礙物。
- 由於信號在室內會受到電子熒光燈、轉換熒光燈或無線電話的干擾，因此，使用遙控器時請靠近冷氣機。
- 當需要更換時，應更換相同型號的新電芯。
- 當長時間不使用遙控器時，請取出電芯。

● 遠程控制面板

注意：

- 如果無線遙控器丟失，則可以使用遙控面板手動操作。
- 說明書中的膜片示意圖僅供參考。請以實際產品為準。

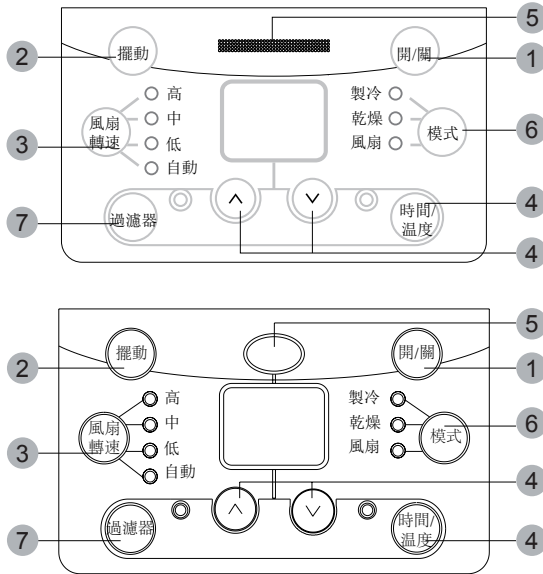

1 開/關按鈕

按下此按鈕時開始運行，再次按下此按鈕後停止運行。

2 擺動按鈕

啓用自動擺風功能。

3 風扇轉速按鈕

依次選擇風扇轉速『低』、『中』、『高』和『自動』。

4 時間/溫度按鈕

按下『∧』按鈕，以提高機組的設置（工作）溫度。按下『∨』按鈕，以降低機組的設置（工作）溫度。溫度設置範圍為16~30°C。按下『∧』按鈕，以0.5小時為增量增加所選時間；按下『∨』按鈕，以0.5小時為增量減少所選時間。時間設置範圍為0~10小時。按下『∧』按鈕，以1小時為增量增加所選時間；按下『∨』按鈕，以1小時為增量減少所選時間。時間設置範圍為10~24小時。

按下「時間/溫度」按鈕後，LED指示燈會閃爍。當LED燈閃爍時，使用∨ ∧鍵盤設定時間。5秒後，確認計時器，LED指示燈會亮起。設備運行期間，顯示屏返回至設定溫度。設備停止期間，時間顯示關閉。

如果要取消計時器設定，按下「時間/溫度」按鈕，在LED指示燈閃爍時，再次按下「時間/溫度」按鈕，LED指示燈將熄滅。

5 信號接收器

6 模式按鈕

選擇操作模式：製冷、乾燥、風扇、制熱（用於逆向循環型號）或製冷、乾燥、風扇（僅用於製冷型號）。

7 過濾器按鈕

此功能提醒用戶清洗空氣過濾器（請參閱『保養和清洗』部分），以提高運行和製冷效率。運行250小時後，LED（燈）將點亮。為在清洗過濾器後重置，按下檢查過濾器按鈕，指示燈將熄滅。在LED（燈）點亮之前，按下檢查過濾器按鈕，3秒鐘後，累計運行時間將被刪除。

8 記憶功能

本產品具備記憶功能，因此如果在設備運行時拔掉電源插頭或因停電而導致電源中斷，則在恢復供電後，設備將恢復運行。

無論設備是運行還是停止，計時器功能都會存儲在內存中，並在恢復供電時恢復。

● 操作提示

舒適且經濟地操作

勿使室溫過冷。這對健康不利，而且浪費電力。

保持百葉窗或窗簾關閉。冷氣機運行時，勿讓陽光直接進入房間。

保持室溫均勻。調整垂直和水平氣流方向，以確保室內溫度均勻。不能朝向空氣進入的方向排放空氣。

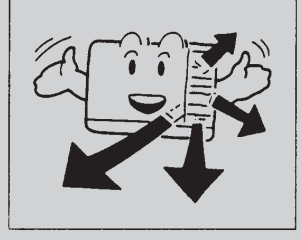
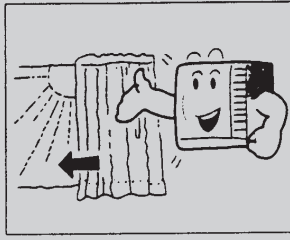
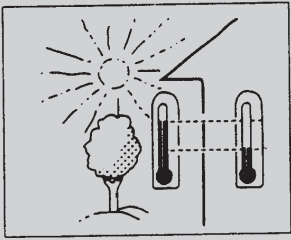

確保門窗緊閉。儘量避免打開門窗，以保持室內的空氣調節狀態。

定期清洗空氣過濾器。空氣過濾器堵塞會降低除濕效果。應至少每兩週清洗一次空氣過濾器。

應偶爾給房間通風。由於窗戶一直是關着的，所以偶爾打開窗戶給房間通風是個好主意。啓動機組時，應關閉窗簾或窗戶，防止漏熱/漏冷。

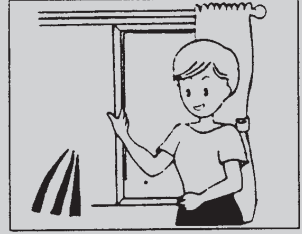
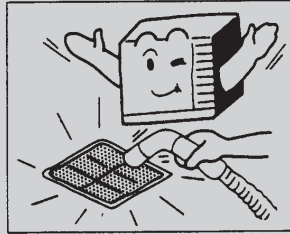
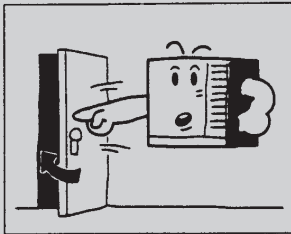

● 注意事項

安全和健康地操作

- 1) 定位好設備後，必須能夠接觸到插頭。
- 2) 請勿在洗衣房內使用此設備。
- 3) 如果電源線損壞，必須由製造商或其服務代理人更換，以免造成危險。

● 請勿拔出電源線。

● 電源線損壞可能導致嚴重觸電。

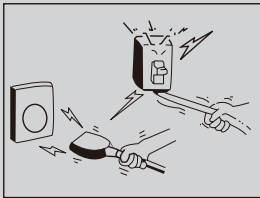

● 除了給房間降溫外，勿將冷氣機用於其他目的。

● 勿將冷氣機用於烘乾衣服、保存食物或種植蔬菜等其他用途。

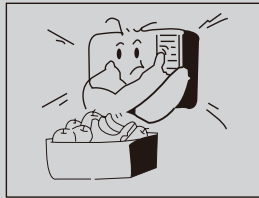

● 勿堵塞進風口和出風口。這會導致設備性能下降和運行不正常。

● 勿將棍子或其他物體插入這些通風口，因為接觸電氣部件和風扇是有危險的。



選擇最合適的溫度。注意調節溫度，以適應室內條件。嬰兒、老人或病人居住的房間應保持適當的溫度。

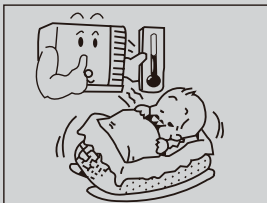

請勿在設備附近使用加熱設備。如果暴露在過熱的環境中，冷氣機的塑料件會融化。

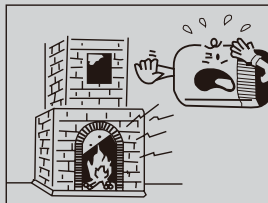

應避免長時間將身體直接暴露於連續的單向氣流中。出於健康原因，不建議這樣做。

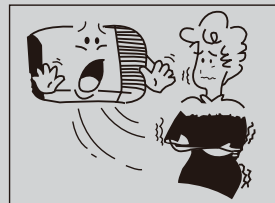

在製冷或制熱過程中關閉冷氣機後，請務必至少等待3分鐘，然後再打開冷氣機。



請注意，機組充裝了輕度易燃製冷劑R32。
機組處理不當會有造成人員和物資嚴重損壞的風險。有關此類製冷劑的詳細信息，請參閱『製冷劑』一章。
本設備使用輕度易燃的製冷劑R32，並按照IEC 60335-2-40進行了測試。本設備在使用時沒有最低房間面積要求。

● 保養與維護

清洗前務必關閉冷氣機和主電源，以確保安全。

清洗機組

1. 清洗前應先切斷電源。

只有在冷氣機完全停止運行後才能拔出插頭。

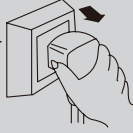

2. 清洗機櫃時應使用軟布。如果機櫃很髒，應將軟布浸入40°C以下的溫水中，擰乾軟布，然後擦掉污垢。



清洗前用手擰乾軟布。

3. 勿使用氣體、苯、溶劑、洗滌液、化學溶劑等進行清洗。



4. 勿將水直接潑濺到有微型計算機和電路板的機組中，這些部件決不能被水浸濕。



可能會發生事故。

- * 檢查接地線

接地線是否斷裂或鬆動？



空氣過濾器

進氣格柵後面的空氣過濾器應至少每兩週清洗一次，或根據需要進行清洗。

如何清洗空氣過濾器：

1. 為拆下進氣格柵，應抓住過濾器上的凸舌並拔出。

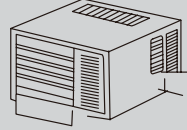

2. 用真空吸塵機吸去過濾器的多塵一面的輕微灰塵。



真空吸塵機

3. 清洗過濾器，較清潔的一面朝上，用和緩流動的水洗出積聚的灰塵和棉絨。



4. 如果過濾器很髒，可在洗滌水中添加溫和的家用洗滌劑。



在重新安裝之前，應讓過濾器徹底乾燥。必要時，可請專業人員進行清洗。





- * 檢查機組的進氣口和出氣口是否堵塞。

氣阻可能導致效率下降



● 故障排除指南

請在要求維修之前檢查以下項目，這樣可以節省時間和金錢。

故障現象	故障排除
<p>冷氣機完全不運行。</p> 	<ul style="list-style-type: none"> ● 是否停電？ ● 是否拔出了插頭？ ● 電源保險絲或開關是否斷開？ ● 電壓是否過高或過低？
<p>製冷或制熱效率</p> 	<ul style="list-style-type: none"> ● 進氣口或出氣口是否堵塞？ ● 房間裏是否有其他熱源/冷源？ ● 空氣過濾器是否很髒？ ● 室內風扇轉速是否設置為『低』？ ● 當機組啓動時，可能房間太熱/太冷。
<p>霧狀空氣流出。</p> 	<ul style="list-style-type: none"> ● 在『製冷』模式運行時，有時會有霧狀空氣從機組中流出，這是因為室內潮濕的空氣一直在快速製冷。 ● 當室內出口發出一些氣味時，機組是正常的，因為進氣空氣可能會混合傢俱和煙霧的氣味。
<p>冷氣機運行時有噪聲。</p> 	<ul style="list-style-type: none"> ● 聽起來像水流的噪聲：這是氟利昂在冷氣機機組內流動的聲音。 ● 聽起來像淋浴的噪聲：這是冷氣機機組內部處理除濕水的聲音。
<p>冷氣機裏好像有冷凝水漏出來了。</p>	<ul style="list-style-type: none"> ● 當冷氣機的氣流冷卻溫暖的室內空氣時，會發生冷凝現象。
<p>重新啓動時，冷氣機大約有3分鐘時間不運行。</p>	<ul style="list-style-type: none"> ● 這是為了保護設備。 ● 等待大約三分鐘後，設備將開始運行。

故障代碼	解決方案
H5	請聯繫專業人員處理。
E5	請聯繫專業人員處理。
E4	請聯繫專業人員處理。
H3	請聯繫專業人員處理。
H5	請聯繫專業人員處理。
PL	請聯繫專業人員處理。
PH	請聯繫專業人員處理。
HC	請聯繫專業人員處理。
Fo	請聯繫專業人員處理。
F3	請聯繫專業人員處理。
F4	請聯繫專業人員處理。
F5	請聯繫專業人員處理。
F0	請聯繫專業人員處理。
E6	請聯繫專業人員處理。
F1	請聯繫專業人員處理。
F2	請聯繫專業人員處理。
U7	請聯繫專業人員處理。

注意：如果還有其他故障代碼，請聯繫合格的專業人員進行維修。

出現以下情況時，請立即停止所有操作並拔出插頭，並聯系經銷商。

- * 運行的啓動或停止情況異常；
- * 電源保險絲或開關經常斷開；
- * 不小心將水或其他液體濺入了冷氣機裏；
- * 電線很熱或電線覆蓋層破損；
- * 其他陌生的情況。



● 其他

- 交流和電源線之間或其他元件之間的獨立連接應以機組上的接線圖為準。
- 保險絲的型號和額定值應在相應的控制器或保護套管上進行絲網印刷。

● 售後服務

- 如果冷氣機有質量問題或其他問題，請聯繫服務中心。

● 易燃製冷劑的安全操作

● 安裝和技術人員的資格要求

1. 所有從事製冷系統工作的人員應持有權威機構頒發的有效證書和本行業認可的製冷系統從業資格證書。如果需要其他技術人員對設備進行維護和修理，則這些人員應在具有使用易燃製冷劑資格的人員的監督下操作。
2. 只能使用設備製造商建議的方法進行修理。

● 安裝注意事項

1. 不允許在有明火（如火源、正在工作的燃氣設備、正在運行的制熱器）的房間內使用冷氣機。
2. 本設備使用輕度易燃的製冷劑R32，並按照IEC 60335-2-40進行了測試。本設備在使用時沒有最低房間面積要求。本設備的最低安裝高度為1000mm。
3. 安裝後必須進行泄漏測試。

● 維護注意事項

1. 檢查維護區域或房間面積是否符合銘牌要求。
 - 只允許在符合銘牌要求的房間內操作設備。
2. 檢查維護區域是否通風良好。
 - 操作過程中應保持連續通風狀態。
3. 檢查維護區域是否有火源或潛在火源。
4. 檢查設備標誌是否完好。
 - 更換模糊或損壞的警示標誌。

● 焊接

1. 如果在維修過程中需要切割或焊接製冷劑系統管道，請按照以下步驟進行操作：
 - a. 關閉機組並切斷電源
 - b. 排出製冷劑
 - c. 用真空吸塵器清掃
 - d. 用N₂氣體清洗
 - e. 切割或焊接
 - f. 攜回服務點進行焊接
2. 應將製冷劑回收到專用儲罐中。
3. 確保真空泵出口附近沒有任何明火，並且埋通風良好。

● 加注製冷劑

1. 使用R32專用的製冷劑加注設備。確保不同種類的製冷劑不會相互污染。
2. 加注製冷劑時，製冷劑儲罐應保持直立。
3. 加注完成後（或尚未完成時），在系統上貼上標籤。
4. 請勿加注過多。
5. 加注完成後，請在試運行之前進行洩漏檢測；拆卸後應再進行一次洩漏檢測。

● 運輸同存放的安全說明

1. 請在卸貨並打開容器之前，使用可燃氣體探測器做檢查。
2. 確保無火源，並嚴禁吸煙。
3. 遵守當地的規則同法律。



SHARP®

SHARP CORPORATION



66139907569