

SHARP



Refrigerant: R600a

Insulation blowing gas: Cyclopentane

冷媒種類 : R600a

絕緣發泡材主要成份 : 環戊烷

香港電器安全規格

(國際電工委員會規格適合)

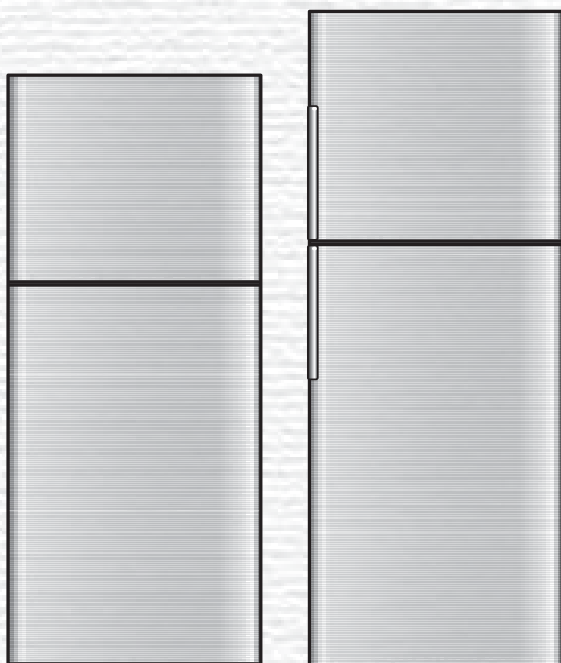

SJ-22G
SJ-25G

SJ-29G

SJ-22G
SJ-25G
SJ-29G

Refrigerator - Freezer Operation manual

Contents

• Safety information	2
• Installation.....	4
• Description	5
• Operation.....	6
• Storing food	7
• Care and cleaning.....	8
• Before calling for service.....	8

原裝進口雪櫃 使用說明書

目錄

• 安全注意事項	9
• 安裝	11
• 各部位名稱	12
• 使用方法	13
• 食品的儲存	14
• 保養	15
• 送修之前的初步檢查	15

Thank you very much for buying this SHARP product. Before using your SHARP refrigerator, please read this operation manual to ensure that you gain the maximum benefit from it.

- This refrigerator is intended for making ice cubes, refrigerating and freezing food.
- This refrigerator is for household use only, with ambient temperature indicated between +5°C and +43°C.
- The refrigerator should not be subjected to temperatures of -10°C or below for a long period of time.

Household use only

Safety information

 **Warning** This means that there are high risks of death or serious injury.

 **Caution** This means that there are high risks of material damage or personal injury.



Warning

Refrigerant

This refrigerator contains flammable refrigerant (R600a: isobutane) and insulation blowing gas (cyclopentane). Observe the following rules to prevent ignition and explosion.

- Do not allow any sharp objects to have contact with the refrigeration system. The refrigeration system behind and inside the refrigerator contains refrigerant.
- Do not use mechanical devices or other means to accelerate the defrosting process. (This refrigerator has adopted automatic defrosting system)
- Do not use electrical appliances inside the refrigerator.
- Do not block the space around the refrigerator.
- Do not use flammable sprays, such as spray paint near the refrigerator.
- In the case of failure of the refrigeration system, do not touch the wall socket and use open flames. Open the window and air out the room. Then ask a service agent approved by SHARP for service.

Installation

- Do not install the refrigerator in a damp or wet location. It may cause the damage to the insulation or electrical leak. Dew may also appear on the outer cabinet and it causes rust.
- The refrigerator should be installed flatly and firmly on the floor.

Power cord, Plug, Socket

Read carefully the following rules to prevent electric shock or fire.

- Connect the power plug into the wall socket firmly and directly. Do not use an extension cord or adapter plug.
- Connect the power plug to the socket with the required rated voltage.
- Connect the earth pin to the earth terminal properly.

- Make sure that the power cord has not been damaged during installation or moving. If the power plug or cord is loose, do not insert the power plug.
- Do not touch the power plug with wet hands.
- Disconnect from the main electricity supply by removing the main plug from the socket. Do not remove by pulling the power cord.
- Dust deposited on the power plug may cause fire. Wipe it off carefully.
- Pull out the plug if the refrigerator is not used for a long time.
- Should the flexible supply cord be damaged, it must be replaced by service agent approved by SHARP as a special cord is required.

In use

- Do not store volatile and flammable materials such as ether, petrol, propane gas, aerosol cans, adhesive agents and pure alcohol etc. These materials are easy to explode.
- Do not store temperature-sensitive products such as pharmaceutical products in the refrigerator. There are high risks of changes in product quality .
- Do not attempt to change or modify this refrigerator. This may result in fire, electric shock or injury.
- Do not place any object on the top of refrigerator. If the object falls down from the top, it may cause injury.
- Do not use other than potable water to make ice cubes.
- This appliance can be used by children aged from 8 years old or above and persons with reduced physical, sensory or mental capabilities or lack of experience and knowledge if they have been given supervision or instruction concerning use of the appliance in a safe way or understanding the hazards involved. Children should be supervised and shall not play with the appliance. Cleaning and user maintenance shall not be done by children without supervision.

Care and Cleaning

- Unplug the refrigerator first to prevent electric shock.
- Do not splash water directly on the outer cabinet or the interior. This may lead to rusting and deterioration of the electrical insulation.

Trouble

- If you smell something burnt, pull out the power plug immediately. Then ask a service agent approved by SHARP for service.
- In case of gas leak, ventilate the area by opening window. Do not touch the refrigerator or the power socket.



Caution

Transportation

- When you install or move your refrigerator, use curing mat to protect the floor from being damaged.
- Carry the refrigerator securely. If you lift up the refrigerator improperly, it may cause injury.

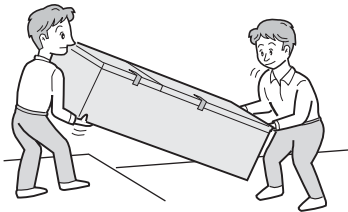

Disposal

- Ensure that the refrigerator presents no danger to children while being stored for disposal. (e.g. remove the magnetic door seals to prevent child entrapment.)
- This refrigerator should be disposed appropriately. Take the refrigerator to a professional recycling plant for flammable refrigerant and insulation blowing gases.

In use

- Do not touch the compressor unit or its peripheral parts, as they become extremely hot during operation and the metal edges may cause injury.
- Do not touch food or metal containers in the freezer compartment with wet hands. This may cause frostbite.
- Do not place bottled drinks and cans in the freezer compartment as they may crack when frozen.
- Do not open or close the door when other people put a hand near the door. There is a risk that the other people may get their fingers caught in the door.
- Do not put oversized object in the pockets of the door. If the object falls down from the pockets, it may cause injury.

- 1** Keep adequate ventilation space around the refrigerator.
The picture shows the minimum required space for installing the refrigerator. The measurement condition of energy consumption is conducted under a different space dimension.

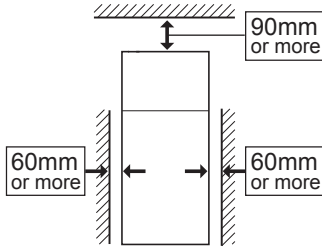

Rear clearance

The space between the rear of the refrigerator and the wall should be 50mm or more, and less than 75mm. If the space is wider than 75mm, you may get injured by touching compressor and its peripheral parts which are extremely hot during the operation.

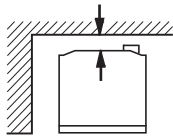

Note

- By keeping greater space, the refrigerator may consume a less amount of power consumption.
- If use the refrigerator in the smaller space dimension than figured, it may cause temperature rise in the unit, loud noise and failure.
- Do not push the refrigerator against the wall. The wall surrounding the refrigerator may get dirty or discolored because of the air flow caused by heat radiation.

Overall space required in use

	SJ-22G SJ-25G	SJ-29G
a	980mm	1080mm
b	1113mm	1215mm

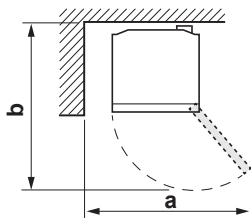

- 2** Use the adjustable foot to place the refrigerator flatly and firmly on the floor.

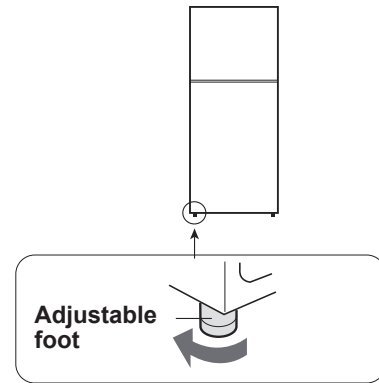

Note

- Place your refrigerator to access the plug.
- Keep your refrigerator out of direct sunlight and do not place next to heat generating appliance.

Before using your refrigerator

Clean the inside parts with a cloth soaked in warm water. If soapy water is used, wipe it off thoroughly with water.

Description

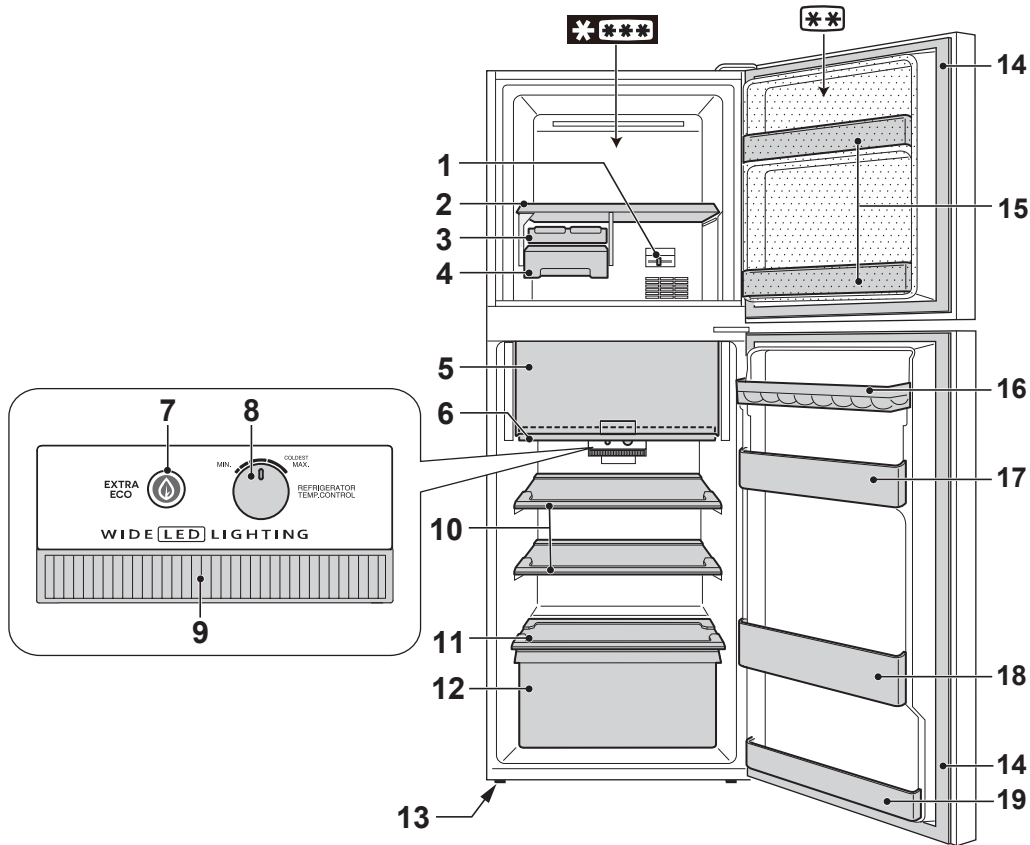

2 star section [**] for storing frozen foods only.

1. Temperature control lever

2. Freezer shelf

3. Ice cube maker

- 1) Do not overfill this tray with water. Otherwise the ice cubes will join together when frozen.
- 2) When ice cubes are made, turn the lever clockwise to put the ice into the ice cube box.

4. Ice cube box

Note: To prevent the ice cube box from being damaged, do not pour oil into the box or make ice in it.

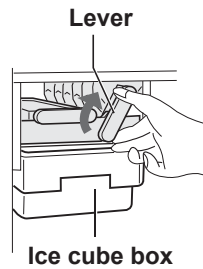

5. Two-way fresh room door

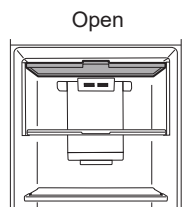

Use the space as refrigerator room.

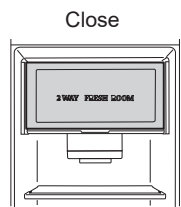

Use the space as fresh room.

How to open Two-way fresh room door

- 1) Lift up the door.
- 2) Insert the door into the frame and push it back to the stopper. It is locked properly.

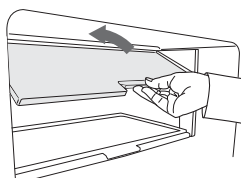

6. Fresh shelf

7. Extra Eco button

8. Temperature control knob

9. LED light

10. Refrigerator shelf

11. Vegetable shelf

12. Vegetable crisper

13. Adjustable foot

14. Magnetic door seal

15. Freezer door pocket

16. Egg pocket

17. Refrigerator door pocket

18. Bottle pocket

19. Utility pocket

Deodorizing unit

Deodorizing catalyst is installed on the routes of cold air. There is no need to operate and clean.

If you wish to store large items within your refrigerator

- You may remove any shelves or any pockets numbered 2,3,4,6,10,11,12,15,16,17,18,19 in the picture above.
- Energy consumption of this model is measured without the ice cube maker and the ice cube box in accordance with the international standards.

Operation

Extra eco mode

Use this mode when you want to switch the refrigerator to energy-saving operation. While this mode is operating, the inside temperature of the refrigerator and freezer compartment becomes higher than the normal operation as follows.

	Freezer compartment	Refrigerator compartment
Under "Extra eco" mode	Approx. 2°C plus	Approx. 1°C plus

Cancel this mode when you feel the beverages are not cooled enough or ice making takes longer time.

How to start the operation

Press "EXTRA ECO" button.

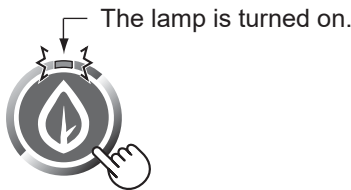

How to cancel the operation

Press "EXTRA ECO" button again.

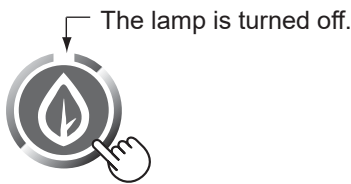

Note

- The efficiency of power saving depends on the usage environment (controlling temperature, ambient temperature, frequency of opening or closing the door, amount of food).

Tips for saving energy

- Install the refrigerator in a well-ventilated area and keep the space to ventilate.
- The amount of energy consumption of this model is measured as shown in the picture below.

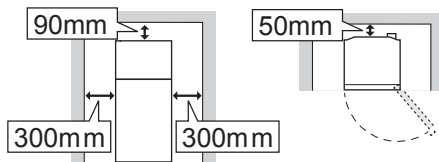

- Keep your refrigerator out of direct sunlight, and do not place it next to heat generating appliance.
- Open your refrigerator door as briefly as possible.
- Hot food should be cooled before storing.
- Place the food evenly on the shelves to allow the cool air to circulate efficiently.

Controlling temperature

Temp. control knob (in the refrigerator compartment)

This knob is for controlling the operation time of compressor of refrigeration system. Max setting will result in colder temperature in the both (refrigerator and freezer) compartments. The freezer compartment may not cool sufficiently when leaving REFRIGERATOR TEMP. as MIN for an extensive period. Turn the knob to the center for normal use.

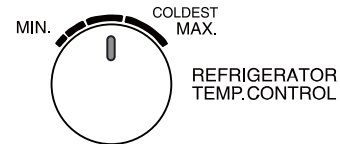

Temp. control lever (in the freezer compartment)

Set the lever to the center for normal use. This lever is for adjusting the proportion of cold air.

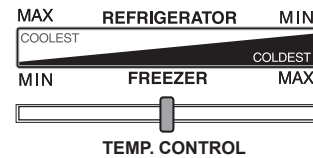

Position of the lever	Condition
Left	Cold air flows into the refrigerator compartment more. The refrigerator compartment is cooled well.
Right	Cold air flows into the freezer compartment more. The freezer compartment is cooled well.

Recommended temperature settings are shown below.

	Temp. control lever	Temp. control knob
Normal		
In summer (Warmer than 35°C)	<ul style="list-style-type: none"> Set to the left side. Do not set to the right. 	
In winter (Colder than 10°C)	<ul style="list-style-type: none"> Set to the right. Do not set to left side. 	

Storing food

Refrigeration reduces the rate of food spoilage.

Ensure that the food is of the freshest possible quality to maximize the shelf life of perishable food.

The following is a general guide to help promote longer food storage.

Fruit / Vegetables

Fruit and vegetables should be loosely enclosed in a plastic material e.g. wrap, bags (do not seal) and placed in the vegetable crisper to minimize moisture loss.

Dairy Products & Eggs

- Most dairy products have their best-before date on the outer packaging which informs the recommended temperature and shelf life of the food.
- Eggs should be stored in the Egg pocket.

Meat / Fish / Poultry

- Place on a plate or a dish and cover with paper or plastic wrap.
- For larger cuts of meat, fish, or poultry, place to the rear of the shelves.
- Ensure all cooked food is wrapped securely or placed in an airtight container.

For best freezing

- Quality of food should be fresh.
- Freeze small quantities of food at a time in order to freeze them quickly.
- Food should be properly sealed or covered tightly.
- Place food in the freezer evenly.
- Label bags or containers to keep an inventory of freezing food.

Advice for preventing dew or frost inside the refrigerator

- Keep the door securely closed. If the food falls down, it may cause a gap between the cabinet and the door. Move it back to the shelf or the pocket.
- Food with high-moisture should be stored in airtight container or sealed tightly.

Note

- Evenly place the food on the shelves to allow the cooling air to circulate efficiently.
- Hot food should be cooled before storing. Storing hot food increases the temperature in the unit and the risk of food spoilage.
- Do not block the outlet and inlet of the cool air circulating circuit with food or containers; otherwise the food can not be evenly cooled throughout the refrigerator.

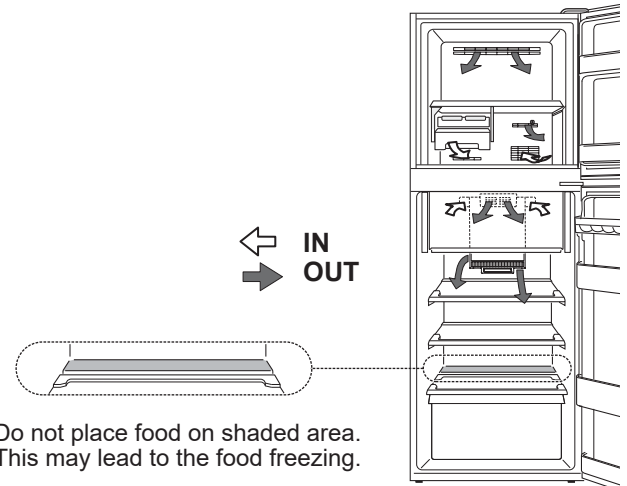

Do not place food directly in front of cold air outlet. This may lead to the food freezing.

Care and cleaning

Important

To prevent cracks on inside surfaces and plastic components, follow these tips.

- Wipe out food oil adhered to plastic parts.
- Some household chemicals may cause damage, so use only diluted washing-up liquid (soapy water).
- If undiluted detergent is used or soapy water is not wiped off thoroughly, it may result in cracks of plastic parts.

Cleaning

- Remove the accessories (e.g. shelves) from the cabinet and the door. Wash them by warm soapy dishwashing water. After that, rinse them in clean water and dry.
- Clean the inside with a cloth soaked in warm soapy dishwashing water. Then, use cold water to wipe off soapy water thoroughly.
- Wipe the exterior with a soft cloth each time it gets dirty.
- Clean the Magnetic door seal with a toothbrush and warm soapy dishwashing water.

Note

- Do not use heavy-duty cleansers or solvents (lacquer, paint, polishing powder, benzine, boiled water, etc.) which may cause damages.
- If you pull out the power plug once, wait 5 minutes at least before connecting the power plug again.
- Do not drop objects inside the refrigerator or strike the inner wall. This may cause cracks to inner surface.

Defrosting

Defrosting is automatically operated by a unique energy saving system.

When the compartment light is blown

Contact the service agent approved by SHARP to replace the light. The light is not to be replaced other than by qualified service personnel.

Switching off your refrigerator

If the refrigerator needs to be switched off for an extended period, the following steps should be taken to reduce the growth of mold:

1. Remove all food.
2. Remove the power plug from the socket.
3. Clean and dry the interior thoroughly.
4. Keep all the doors open slightly for a few days to dry.

Before calling for service

Before calling for service, check the following points.

Problem	Solution
The outside of the cabinet is hot when touching.	It is normal. The hot pipe is in the cabinet in order to prevent dew generation.
When there is refrigerator noise.	It is normal for the refrigerator to make the following sounds. <ul style="list-style-type: none">• Loud noise is made by the compressor when its operation starts<ul style="list-style-type: none">-- Sound becomes quieter after a while.• The compressor makes loud noise once a day.<ul style="list-style-type: none">-- Operating sound is made immediately after automatic defrost operation.• Sound of flowing fluid (gurgling sound, fizzing sound)<ul style="list-style-type: none">-- Sound of refrigerant flowing in pipes (sound may become louder from time to time).• Cracking or crunching sound, squeaking sound<ul style="list-style-type: none">-- Sound produced by expansion and contraction of inner walls and internal parts during cooling.
Frost or dew appears inside or outside the refrigerator.	This may occur in one of the following cases. Use a wet cloth for wiping frost and a dry cloth for wiping dew. <ul style="list-style-type: none">• When the ambient humidity is high.• When the door is frequently opened and closed.• When food containing plenty of moisture is stored. (Wrapping is required.)
The food in the refrigerator compartment freeze.	<ul style="list-style-type: none">• Is the refrigerator operated for a long time with the temp. control knob set at MAX?<ul style="list-style-type: none">-- Change the temperature control to other setting.• If ambient temperature is low, food may freeze even if the the temp. control knob is set to MIN.
Odors in the compartment.	<ul style="list-style-type: none">• Wrapping is required for the food with strong odors.• Deodorizing unit cannot remove all odors.

If you still require service

Refer to your nearest service agent approved by SHARP.

感謝您購買 SHARP 產品。在使用 SHARP 雪櫃之前，為使您能夠充份使用您所購買的雪櫃，請仔細閱讀本使用說明書。

- 本雪櫃可用於製作冰塊、冷藏和冷凍食物。
- 這個雪櫃僅限於家庭用途，使用雪櫃的環境溫度為 +5°C 和 +43°C 之間。
- 雪櫃在一段長時間內不應受到 -10°C 或以下的溫度。

僅限於家庭用途

安全注意事項

 **警告** 這表明導致死亡或重傷的風險很高。

 **安全注意事項** 這表明導致材料受損或人員受傷的風險很高。



警告

冷媒種類

雪櫃含有易燃製冷劑（R600a：異丁烷）和絕熱發泡氣體（環戊烷）。為防止著火和爆炸，請遵守以下規則。

- 雪櫃內部及後側的製冷系統內含有製冷劑。請務必避免任何尖銳的物體碰觸製冷系統。
- 請勿使用機械設備或其他方式來加速除霜過程。（此雪櫃已採用自動除霜系統）
- 請勿在雪櫃內使用電器。
- 請勿堵塞雪櫃周圍的空間。
- 請勿在雪櫃附近使用易燃性噴霧劑，例如噴漆，否則可能會導致爆炸或火災。
- 如果雪櫃的冷卻系統上有損毀，請勿接觸牆壁電源插座，也勿使用明火。打開窗戶，使房間空氣流通。然後聯繫 SHARP 認可的售後服務中心進行維修。

安裝

- 請勿將雪櫃設置在潮濕的地方。這樣會因絕緣失效而導致漏電。而且有時會在雪櫃外側結露。
- 將雪櫃穩妥地安裝在地板的水平位置上。

電源線，插頭，插座

為防止觸電或火災，請仔細閱讀以下規則。

- 直接將電源插頭地插入牆壁電源插座。請勿使用延長的電線或轉換插頭。
- 將電源插頭插入符合額定電壓要求的插座上。
- 正確地將接地線連接到接地端子。

- 在安裝或移動的過程中，請確保電源線完好無損。如果電源插頭或電源線出現鬆動等情況，請勿插入電源插頭。
- 請勿用濕手接觸電源插頭。
- 拔出電源插頭時，請不要只拉住電源線，應該拿住插頭端拔出。
- 電源插頭上積滿灰塵是引起火災的原因。因此，請時常將其擦淨。
- 雪櫃如果長時間不使用，請將插頭拔出。
- 電源線損壞時，請到 SHARP 認可的售後服務中心更換。因為需要特定的電源線。

使用中

- 請勿儲藏揮發性物質和易燃性物質，如乙醚、汽油、丙烷氧、粘合劑、純乙醇等。此類物質有爆炸之危險。
- 請勿在雪櫃內儲存溫度敏感型產品，例如醫藥產品。否則產品極可能會變質。
- 請勿改裝雪櫃。修理技術人員以外的人員拆卸和修理本機，會導致火災、觸電和受傷。
- 請勿在雪櫃頂部放置任何物品。如果物品從雪櫃頂部掉落，可能會導致人員受傷。
- 請勿用飲用水以外製作的冰塊。
- 此雪櫃適合 8 歲及以上的兒童使用。在有符合電器使用安全的監督或指導及了解潛在危險的前提下，此雪櫃也適合身體、感官或智力方面有缺陷的殘障人士、或者缺乏相關經驗或知識的人士使用。禁止讓兒童玩弄雪櫃。在無任何監督的情況下，兒童不得對雪櫃進行清潔及維修保養。

保養

- 為了防止觸電，首先拔掉雪櫃的電源插頭。
- 請勿直接將水灑在雪櫃的內部和外部。這樣會導致生鏽及絕緣性能下降。

故障

- 如果聞到燒焦的味道，請立即拔出電源線，然後聯繫 SHARP 認可的售後服務中心進行維修。
- 萬一發生瓦斯氣漏事故，請勿用手去觸摸雪櫃和插頭，要打開窗戶通風。



安全注意事項

運輸

- 安裝或移動雪櫃時，請使用防護墊以防止地板受損。
- 請妥善搬運雪櫃。如果抬起雪櫃的方式不當，可能會導致人員受傷。

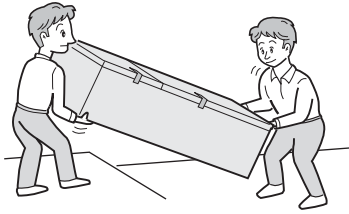

廢舊雪櫃的處理

- 確保雪櫃在等候處理的過程中不會給兒童帶來危險。（例如拆除門封以防兒童不慎卡入。）
- 請妥善處理雪櫃。雪櫃請運送至專業的可燃性製冷劑及絕熱發泡氣體廢料處理廠。

使用中

- 由於壓縮機單元或者其外圍部件在操作過程中將變得非常燙手，千萬不要去觸摸，否則，將會被金屬邊緣燙傷。
- 不要用濕手去觸摸冷凍室內的食品 and 金屬製容器。恐會導致手凍傷。
- 請勿將瓶裝或罐裝飲料放入冷凍室。
- 當其他人的手靠近雪櫃門時，請勿打開或關閉雪櫃門，否則雪櫃門會夾到其他人的手。
- 請勿在雪櫃門的雪櫃門架上放置尺寸過大的物品。如果該物品從雪櫃門架上掉落，可能會導致人員受傷。

- 1** 雪櫃的周圍應確保足夠的通風空間。圖中顯示出安裝雪櫃所需要的最低限度的空間。耗電量的測試需在不同空間條件下進行。

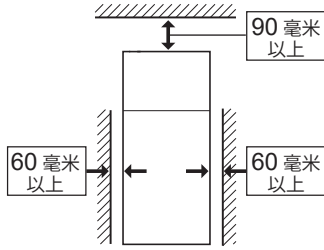

雪櫃後方間隙

雪櫃後部與牆體之間的空間距離應為大於 50 毫米且小於 75 毫米。若此空間大於 75 毫米，切勿觸摸在運行中過熱的壓縮機以及外圍部件，以免受傷。

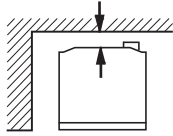

請注意

- 雪櫃周圍的空間越大，雪櫃運行時的耗電量越小。
- 若在小於以下圖所示尺寸的空間內使用雪櫃，可能會導致裝置溫度升高，噪音加大和其他故障。
- 請勿將雪櫃往牆的方向推。雪櫃周圍的牆壁會因熱輻射產生的氣流而變髒或褪色。

使用時所需總體空間

	SJ-22G SJ-25G	SJ-29G
a	980 毫米	1080 毫米
b	1113 毫米	1215 毫米

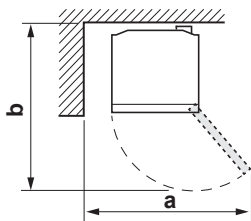

- 2** 使用調整腳將雪櫃穩妥地安裝在地板的水平位置上。

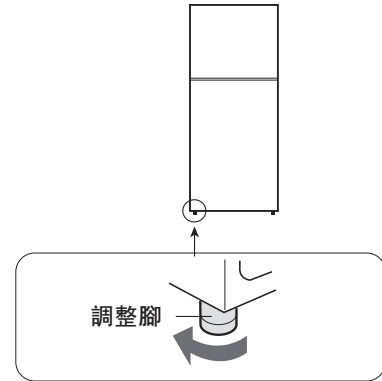

請注意

- 設置雪櫃時要充分考慮便於插拔電源插頭。
- 請勿將雪櫃放在陽光直射的地方或發熱機器的旁邊。

在使用雪櫃前

用溫水浸泡過的軟布清潔雪櫃內部。如果使用肥皂液，請用水徹底擦掉殘留肥皂液。

各部位名稱

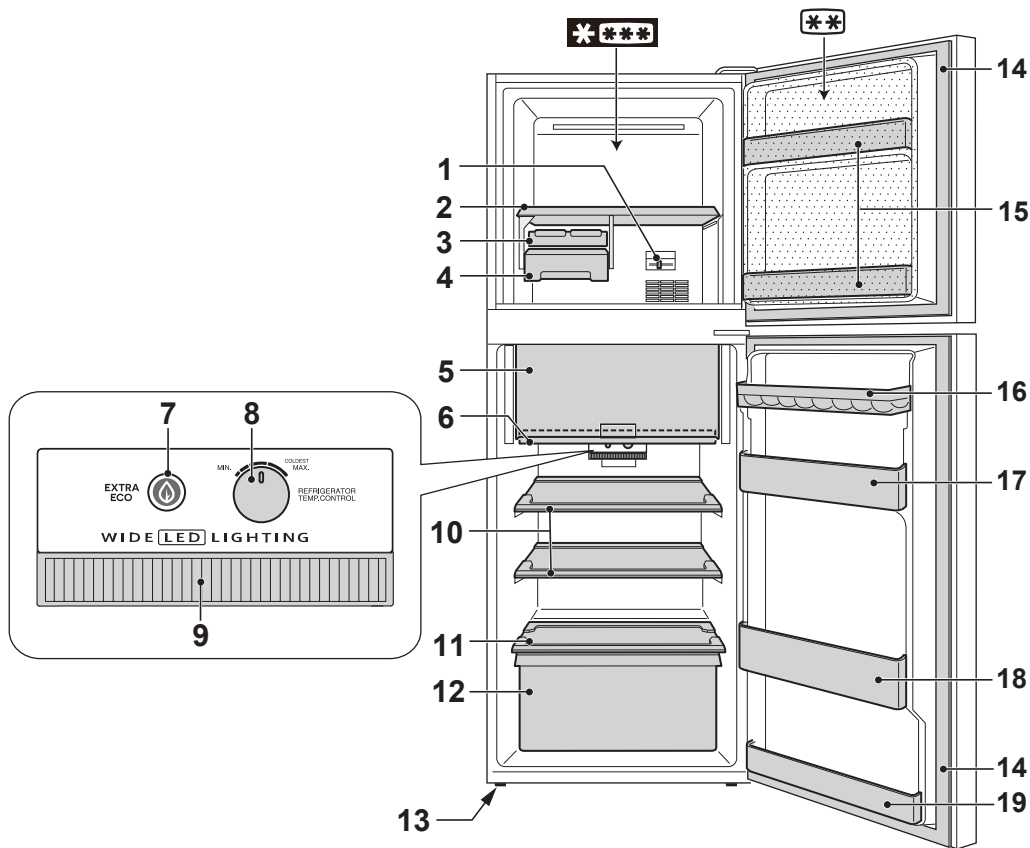

兩個星號區域 (**), 只能保存冷凍狀態。

1. 溫度調節器

2. 冷凍室層架

3. 旋轉式雙製冰盒

- 1) 請勿將過量的水放入製冰盒內。否則，製成的冰會連結在一起。
- 2) 冰製成以後，請按順時針方向轉動控制桿，將冰倒進儲冰盒內。

4. 儲冰盒

請注意：為防止儲冰盒損壞，請勿在儲冰盒內放入油脂類或製冰。

5. 兩用保鮮室門

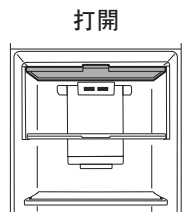

將此空間用作冷藏室。



將此空間用作保鮮室。

打開兩用保鮮室門的方法

- 1) 提起保鮮室門。
- 2) 將保鮮室門插進雪櫃架中並推回至限位器。保鮮室門已卡好。

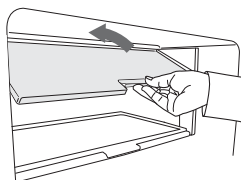

控制桿

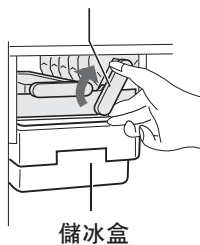

儲冰盒

6. 保鮮層架

7. 節約能源按鈕

8. 溫度調節旋鈕

9. LED 燈

10. 冷藏室層架

11. 蔬果層架

12. 蔬果保鮮室

13. 調整腳

14. 門封

15. 冷凍室門架

16. 蛋架

17. 雪櫃門架

18. 瓶架

19. 小物品架

脫臭裝置

已經將脫臭觸媒設置在冷氣的通道上。不需要進行操作和清潔。

若需要在雪櫃內儲存大件物品

- 您可移除上方圖片中標號為 2、3、4、6、10、11、12、15、16、17、18、19 中的任何層架或小物品架。
- 此模式的耗電量是根據國際標準測量而得，不計製冰盒及儲冰盒的能耗。

使用方法

節約能源功能

如果想讓雪櫃轉換為節約能量的運轉狀態，請使用該功能。運行該功能時，冷藏室和冷凍室內的溫度會高於以下常規操作。

	冷凍室	冷藏室
在「節約能源」功能下	上升大約 2°C	上升大約 1°C

如果覺得飲料不夠冰涼或製冰太費時，可取消此功能。

啟動此操作的方法

按下「EXTRA ECO」按鈕。



取消此操作的方法

再按一次「EXTRA ECO」按鈕。



請注意

· 節能效率取決於使用環境（周圍溫度，開關雪櫃門的頻率，食物總量）。

節約能量的竅門

- 將雪櫃安裝於通風良好的區域內並保持該空間的通風。
- 此模式的耗電量如下圖所示測量而得。

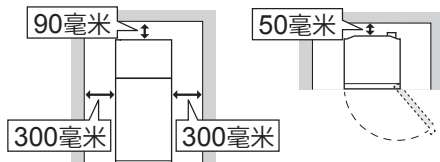

- 請勿將雪櫃放在陽光直射的地方或發熱機器的旁邊。
- 盡量避免開門。
- 請將較熱的食物涼下來後才保存起來。
- 為使冷氣充分循環，請將食品均勻地放在層架上。

溫度調節

溫度調節旋鈕（位於冷藏室內）

此鈕的作用是用於控制冷卻系統中的壓縮機的運轉時間。將溫度設為 MAX 時，將會降低兩個儲藏室（冷藏室和冷凍室）的溫度。若長期將冷藏室溫度設定在 MIN 處，冷凍室未必能冷卻。請將冷藏室溫度調校至偏向 MAX 處，以適當地冷卻冷凍室。將此鈕調至中間以供正常使用。

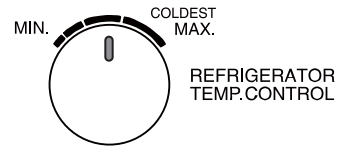

溫度調節器（位於冷凍室內）

將冷凍室溫度調至中間以供正常使用。冷凍室溫度調節器可調節冷凍室內的冷氣量。

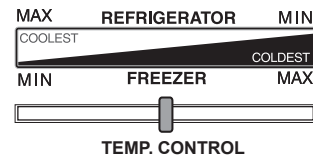

溫度調節器的位置	狀態
左	進入冷藏室的冷氣量更多。冷藏室製冷狀態良好。
右	進入冷凍室的冷氣量更多。冷凍室製冷狀態良好。

推薦的溫度設定如下所示。

	溫度調節器	溫度調節旋鈕
正常		
夏季 (氣溫超過 35°C)		
冬季 (氣溫低於 10°C)		

食品的儲存

將食品冷藏起來時，食品腐爛的速度就會減慢。
要延長易於腐爛食品的保存期限，就應當盡量選擇較新鮮的食品。
下面為延長食品保存期限的簡要介紹，可供您參考。

水果／蔬菜

為盡量減少水份的流失，水果和蔬菜要用保鮮紙及膠袋輕輕包上（不封口），並將其放入蔬果保鮮室內。

乳製品和雞蛋

- 幾乎所有乳製品的包裝上都標有適當的保存溫度和保存期限。
- 請用箱內的蛋架保存雞蛋類。

肉類／魚／禽肉

- 請將其放在容器上，並包上保鮮紙。
- 若是大塊的肉、魚和禽肉，請將其放在層架的內側。
- 已經煮熟的食品務須用保鮮紙包好，或將其放在密封容器內。

為達到最佳冷凍效果

- 食品質量應當新鮮。
- 若要快速冷凍食品，每次都必須少量放入。
- 食品應進行恰當密封，要封緊或蓋緊。
- 將食品均勻地放入冷凍室。
- 袋子和容器上要標上標示，並寫清楚冷凍食品的內容。

防止雪櫃內部結水珠或結霜的建議

- 請妥善關好雪櫃門。如果雪櫃內的食品掉落，可能會導致雪櫃櫃體和門之間形成縫隙。請將食品放回雪櫃內的層架或保鮮室。
- 高水分食品應放在密封容器內保存或密封保存。

請注意

- 為使冷氣充分循環，請將食品均勻地放在盤架上。
- 請將較熱的食品涼下來以後，才保存起來。如果將較熱的食品放進雪櫃，雪櫃內的溫度會升高，這樣往往很容易導致食品腐爛變質。
- 請勿讓食品和容器擋住使冷氣循環的出風口和吸入口。否則，食品就不能均勻地冷卻。

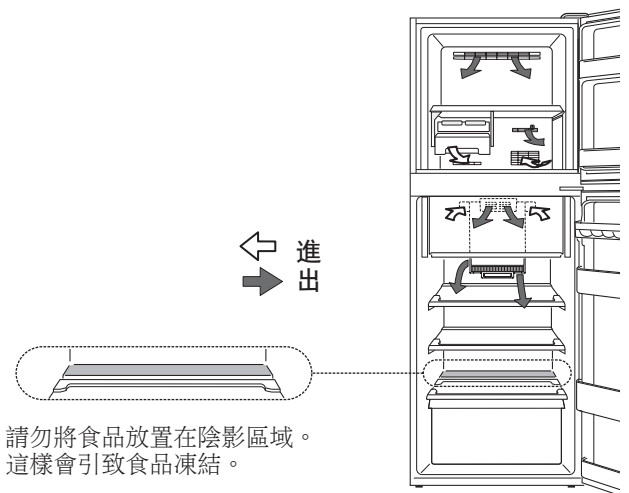

請勿直接將食品放在冷氣出風口旁。
這會引致食品凍結。

保養

重要提示

為防止雪櫃內板表面和塑膠部件發生開裂，請遵從如下操作提示。

- 食用油沾上塑料部件時，請將之擦掉。
- 某些家用化學清潔劑可能會導致雪櫃損傷，因而只能使用稀釋過的廚房用清潔劑（肥皂水）。
- 如果使用未稀釋的清潔劑或者未徹底擦淨肥皂水，則有可能損壞雪櫃的塑料部件。

清潔

- 拆下雪櫃門的層架和櫃門的儲存架。用溫水和廚房用清潔劑清洗，然後，用水洗清並使之乾透。
- 雪櫃內部要用浸泡在廚房用清潔劑的溫水裡的布塊擦洗。然後，用冷水將肥皂水徹底擦乾淨。
- 雪櫃的外殼沾上污漬時，請用柔軟的布塊擦洗。
- 雪櫃門封要用廚房用清潔劑的溫水和牙刷洗淨。

請注意

- 請勿使用強力清潔劑或溶劑（油漆、塗料、拋光粉、汽油、沸水等），否則可能導致雪櫃損傷。
- 一旦拔出電源插頭，請等待至少 5 分鐘之後再重新接通電源。
- 在雪櫃內請勿使物體掉落，或用物體強烈碰撞內壁。否則可能導致內壁破裂。

除霜

本雪櫃透過獨特的節約能源系統，完全實現自動除霜。

當冷藏室內燈損壞時

請聯繫 SHARP 認可的售後服務中心更換冷藏室內燈。非專業服務人員不得更換冷藏室內燈。

切斷雪櫃的電源時

如需將雪櫃長時間關閉，應遵循以下步驟以減少霉菌增長：

1. 將食物全部取出。
2. 將電源插頭從插座中拔出。
3. 將內部徹底清潔並乾淨。
4. 將雪櫃門打開數天並晾乾。

送修之前的初步檢查

送修之前，請對下列地方進行檢查。

問題	對策
雪櫃外箱有時會變熱。	這並非異常。防止結露的熱導管裝在機身的內部。
雪櫃發出噪聲時。	雪櫃如發出下述聲音，這並非異常。 <ul style="list-style-type: none">· 運轉開始時，壓縮機發出較大的噪音<ul style="list-style-type: none">— — — 不久聲音會變小。· 壓縮機每日一次發出較大噪音<ul style="list-style-type: none">— — — 緊隨自動除霜操作之後發出的運轉聲。· 液體流動的聲音（咕嚕聲、嘶嘶聲）<ul style="list-style-type: none">— — — 冷媒在管道內流動的聲音（聲音時而會變得較大）。· 劈啪聲或吱嘎聲，吱吱聲<ul style="list-style-type: none">— — — 冷卻時內壁和內部零件膨脹和收縮的聲音。
雪櫃內部和雪櫃外側結霜或結露。	在下列情形下有可能發生這種現象。請用濕布擦掉霜，用乾布擦掉露珠。 <ul style="list-style-type: none">· 周圍溫度較高時。· 頻繁開啓雪櫃門時。· 雪櫃內存放水分較多的食品時。（請用保鮮紙包上）
冷藏室的食品結凍。	<ul style="list-style-type: none">· 冷藏室溫度調節旋鈕是否設定在 MAX 的狀態下？<ul style="list-style-type: none">— — — 將溫度調節設定改為其他設定。· 在環境溫度較低時，即使將溫度調節旋鈕控制到 MIN，食品有時也會被凍結。
雪櫃內部有異味。	<ul style="list-style-type: none">· 請將氣味較強的食品用保鮮紙包起來。· 脫臭裝置不能去掉所有異味。

經檢查後仍需要送修時

請與就近的 SHARP 售後服務中心洽詢。

SHARP
SHARP CORPORATION