

SHARP

SHARP

Operation manual of front load washer dryer

WASHER DRYER

ES-FWD105AJ-B

Operation manual

Thank you for purchasing our product.

Please read this manual carefully before use.
Please read "Safety precautions" carefully before use.
Please keep this manual in a safe place.
Our product is specially designed for household use only.

Table of contents	Page
● Safety precautions	1
● Installation	7
Parts	7
Product specifications	8
Installation requirements	9
Unpacking the washing machine	11
Removing the shipping bolts	12
Attaching the bottom covers	12
Adjusting the adjustable feet	13
Water inlet installation	14
Positioning the drain hose	15
● Before using the washing machine	16
Inspection and preparation before washing	16
Using methods of detergents and additives	18
● Operations	19
Control panel	19
Simple steps to start	20
Program overview	21
Available options list	23
Function buttons	24
Icons	26
Setting mode	28
● Maintaining the washing machine	29
Cleaning the detergent dispenser	29
Cleaning the enclosure	29
Drum cleaning	30
Cleaning the drain pump filter	30
Cleaning the water supply valve filter	32
Handling the frozen washing machine	33
Storing the washing machine	33
● Troubleshooting	34
Problems and solutions	34
Error messages description	38

Safety precautions

To ensure your safety, proper operation, and long service life, read this manual carefully, and follow the instructions when installing, operating, and maintaining the washing machine.

We are not liable for any damages resulting from improper use.

Keep this manual in safekeeping so that it can be referred to at any time when needed. There are precautions marked with symbols such as "Warning" or "Caution" throughout this manual. However, those precautions do not cover all possible conditions and/or situations that may occur.

Important safety symbols and precautions

Meanings of icons and symbols in this manual:



WARNING

Hazards or unsafe practices that may result in severe personal injury, death or property damage.



CAUTION

Hazards or unsafe practices that may result in personal injury or property damage.

General precautions about this product

- This appliance is not intended for use by persons (including children) with reduced physical, sensory or mental capabilities, or lack of experience and knowledge, unless they have been given supervision or instruction concerning use of the appliance by a person responsible for their safety.
- Children should be supervised to ensure that they do not play with the appliance.
- Children of less than 3 years should be kept away unless continuously supervised.
- If the supply cord is damaged, it must be replaced by the manufacturer, its service agent, or similarly qualified persons in order to avoid any possible hazards.
- Ventilations openings must not be obstructed by a carpet or any similar objects.
- This washing machine is intended to be used in household only and not in applications such as:
 - Staff kitchen areas in shops, offices and other working environments
 - Farm houses
 - By clients in hotels, motels and other residential type environments
 - Bed and breakfast type environments
 - Areas for communal use in blocks of flats or in launderettes
- Use a new water supply hose for connection to the water faucet. Reusing old hoses can cause a water leak and subsequent property damage.
- In order to achieve the high quality required by customers, a comprehensive quality inspection has been carried out in the factory using water. There may be a small amount of water left, or the door glass may be foggy or dripping. Not Unusual.

Safety precautions

Precautions about installation

- Never attempt to operate the washing machine if it is damaged, malfunctioning, partially disassembled, or has missing or broken parts, including a damaged cord or plug.
- The installation of the washing machine must be performed by a qualified technician or service company.
 - Failure to do so may result in electric shock, fire, an explosion, problems with the product, or injury.
- Periodically check the water supply hose for expansion, kink, breakage, tear, and water leak. Replace the hose promptly if there is any abnormality.
- Do not store or install the washing machine in unsuitable places such as:
 - Damp places (such as a bathroom)
 - Oily or dusty places
 - Places subject to weathering conditions (such as direct sunlight, wind, rain, or temperature below freezing)
- Do not use an electric transformer.
 - This may result in electric shock or fire.
- This washing machine must not be installed behind a lockable door, a sliding door or a door with a hinge on the opposite side to that of the washing machine, in such a way that a full opening of the door of washing machine is restricted.
- This washing machine is equipped with a power cord having a grounding function. Use them to ensure that the machine is grounded properly. In the event of malfunction or breakdown, grounding will reduce the risk of electric shock by providing a path of least resistance for electric current.
- Plug the power cord firmly into a professional AC power outlet with voltage of AC 220V-240V, frequency of 50 Hz. If connected to an inappropriate power source, electric shock or fire may result.
- Ensure that the power plug is plugged into an appropriate socket outlet and grounded in accordance with all local codes and ordinances.
- Improper connection of the equipment-grounding conductor can result in risk of electric shock. Check with a qualified electrician or service personnel if you are in doubt as to whether the washing machine is properly grounded.
- Do not modify the plug attached to the washing machine. If the plug cannot match the socket, a suited one should be installed by the manufacturer, product and service agent or qualified person.
- Plug the power plug into the wall socket so that the cord is running towards the floor. If you plug the power plug into the socket in the opposite direction, the electric wires within the cable may be damaged and this may result in electric shock or fire.
- Do not allow the washing machine to contact or be close to any heat source (such as heater, mosquito coil, candle, cigarette, hair dryer, etc.) or inflammable material.

Safety precautions

Precautions about operation

- Do not attempt to repair the washing machine by yourself. Repairs made by inexperienced or unqualified persons may make more serious damage to the washing machine and cause personal injury.
- Do not repair or replace any part of the washing machine. All repairs and servicing must be performed by qualified service personnel unless specifically recommended in this User Manual.
- Use only authorized factory parts.
- Do not touch the power plug with wet hands. Doing so may cause electric shock hazard.
- Do not unplug the power plug while an operation is in progress. Plugging the power plug into the wall socket again may cause a spark and result in electric shock or fire.
- Unplug the power plug when the washing machine is not being used for long periods of time or during a thunder or lightning storm. Otherwise there is a risk of electric shock or fire.
- Pets and children may climb into the washing machine. Keep children away from the washing machine while it is in use.
- Do not leave the machine door open. Children may hang on the door or crawl inside the washing machine, causing damage or injury.
- Never reach into the washing machine while it is operating. Wait until the drum has completely stopped.
- In case of flood, disconnect the power plug, turn off the water supply faucet, and contact the after-sales service department. There is a risk of electric shock.
- Do not push down the door excessively when the machine door is open.
- Do not touch the door while the washing machine is operating in high temperature.
- Before you open the door of the washing machine, check if the drum has been drained. Do not open the door if you can still see water.
- Do not open the washing machine door by force while it is operating (high-temperature washing/drying/spinning). Otherwise, water flowing out of the washing machine may cause burns, or injury by causing the floor to be slippery.
In addition, the door cannot be opened for user's safety, and opening the door by force may result in damage to the product or injury.
- Do not insert your hand or a metal object under the washing machine while it is operating. Doing so may result in injury.
- Make sure not to get your finger (and especially children's finger) caught when opening or closing the door. Doing so may result in injury.
- Keep the water inlet faucet open when washing or drying. Otherwise, the washing or drying procedure may not function properly.
- Do not stand on the washing machine or place objects (such as laundry, lighted candles, lighted cigarettes, dishes, chemicals, metal objects, etc.) on the washing machine.
Doing so may result in electric shock, fire, problems with the product, or injury.
- Keep all washing detergents, softener and bleach away from children.
- Do not use a strong acid cleanser as a laundry detergent.

Safety precautions

- Do not use gasoline, alcohol, dry cleanser or other flammable or explosive substances as a laundry detergent.
- Use household detergents which are available on the market and applicable to machine wash only.
- Make sure that the pockets of all clothing to be washed are empty. Hard, sharp objects such as coins, safety pins, nails, screws, or stones can cause extensive damage to the washing machine.
- Do not wash the clothing with hasp or other heavy metals.
- Do not wash the clothing soaked in or stained with gasoline or other flammable, explosive or toxic substances. There is a risk of fire or explosion.
Wash the clothing aforesaid manually in hot water and an extra amount of detergent first, and ensure that all those liquid, solid and particle traces are removed before putting it into the washing machine. Hazardous substances include acetone, alcohol, gasoline, kerosene, certain liquid household cleanser and detergent, turpentine, wax, and wax remover.
- Do not wash, spin, or dry any items other than normal clothes or sheets, namely as follows:
 - Rugs, mats, pet blankets, woolen bedding, sleeping bags
 - Thick clothings such as fishing vests, ski pants, diaper covers, or sweat suits
 - Waterproof sheets such as rain covers or car covers
- Do not wash thick or hard mats even if the washing machine mark is on the care label. This may result in injury or damage to the washing machine, walls, floor, or clothing due to abnormal vibrations.
- Do not wash throw rugs or doormats with rubber backing. The rubber backing may come off and stick to inside the drum, and this may result in malfunction such as a drainage error.
- Insert the laundry into the washing machine completely so that the laundry does not get caught in the door. If laundry gets caught in the door, it may result in damage to the laundry or the washing machine, or result in a water leak.
- Ensure that the rubber seal and front door glass are not contaminated by a foreign substances (e.g. waste, thread, hair, etc.). If a foreign substances is caught in the door or the door is not completely closed, it may cause a water leak.
- Do not wash large laundry items such as bedding in the washing net. There is a risk of injury due to abnormal vibrations.

Safety precautions

Precautions about using the dryer

- Make sure to carefully check the washing symbols on garments before drying.
- Remove all objects from pockets such as lighters and matches.
- Items that have been soiled with substances such as cooking oil, vegetable oil, acetone, alcohol, petroleum, kerosene, spot removers, turpentine, waxes and wax removers should be washed in hot water with an extra amount of detergent before being dried in the washing machine.
- Do not dry any clothing that is susceptible to discoloration or cracking, such as garments that have lace or printing.
- Do not dry unwashed items in the washing machine.
- When drying, do not open the drawer, there may be steam overflow resulting in burns.

Precautions about maintenance

- Cleaning and user maintenance shall not be made by children without supervision.
- When unplugging the power cord, grip the power plug firmly and pull it straight out of the socket outlet. Pulling the power cord may damage it and result in a short-circuit, fire and/or electric shock.
- Do not use the a strong acidic cleaning agent for cleaning the washing machine.
- Do not use benzene, thinner or alcohol to clean the washing machine. Otherwise there is a risk of discolouration, deformation, damage, electric shock, or fire.
- Remove all foreign substances such as dust or water from the power plug terminals and contact points using a dry cloth on a regular basis. Otherwise there is a risk of electric shock or fire.

Safety precautions

Protecting the environment

- This washing machine is manufactured from recyclable materials. If you decide to dispose of this washing machine, please check local waste disposal regulations. Cut off the power cord so that the washing machine cannot be connected to a power source. Remove the door so that animals and small children cannot get trapped inside the washing machine.
- Do not exceed the detergent quantities recommended in the detergent manufacturer's instructions.
- Use stain removal products and bleaches before the wash cycle only when strictly necessary.
- Save water and electricity by only washing full loads (the exact amount depends upon the program used).

Installation

Strictly observe the relevant installation procedures in the manual to ensure that you use the washing machine safely.

Parts

Unpack your washing machine and inspect it for shipping damage. Also make sure that you have received all items shown below. If the washing machine was damaged during shipping or you do not have all items, contact the place you purchased immediately.

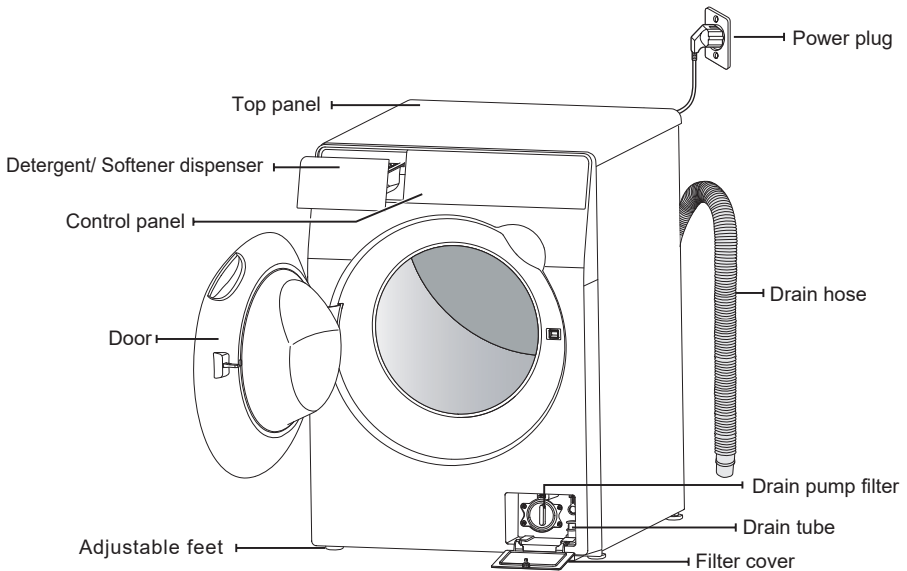

Accessories

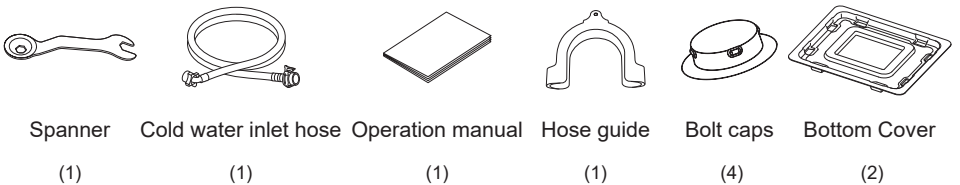

CAUTION

- This washing machine must be connected to the water supply by a new hose (please use the inlet hose accompanying with this washing machine). No old hose is allowed.
- Please use socket wall with earthed connection.

Installation

Product specifications

Model	ES-FWD105AJ-B
Rated capacity	10.5kg
Drying capacity	7.0kg
Rated voltage	220V~
Rated frequency	50Hz
Drying power	1500W
Water pressure	0.03 - 0.8MPa
Rated heating washing power	1800W
Spin speed (Maximum)	1400rpm
External dimensions(W x D x H)	598×600×850mm
Net weight	75kg

Installation

Installation requirements

Power supply

- To avoid the unnecessary risk of fire, electric shock or personal injury, all electrical circuit and grounding must be set as per the national electrical standard.
- Do not overload the wall power socket.
- Ensure that your power supply unit can meet the normal load requirements of the washing machine.
- The power cord has to be positioned so that it will not be stepped on, pressed or clamped by the article on or next to it. Pay special attention to the power cord of plug, socket and power cord contact of the washing machine.
- Do not use an extension cord or double adapter.
- Do not modify the provided plug. If it does not fit the outlet, call a qualified electrician to install a proper outlet.

Water supply

- The working water pressure of the washing machine is 0.03MPa-0.8MPa. When the water pressure is below 0.03MPa, the water supply valve may not work normally, or the time of water supply is longer than that of program control, and the display screen shows "E01".
- The water supply faucet must be less than 122cm away from the rear of the washing machine so that the water supply hose can be easily connected to the washing machine and the water faucet.
- The washing machine shall be close to the water faucet.
- Turn off the water faucet when the washing machine is not used.
- Check water leakage conditions of the internal loop regularly.
- Before using the washing machine, first check all connections of the water supply valve and water faucet to prevent water leakage.

Installation

Installation requirements

Installation location

- Do not position the washing machine on a platform or a structure with weak support.
- To make the most of the washing machine, position it on a hard, flat and clean surface without any water or oil.
- Avoid direct sunlight, with adequate ventilation.
- Room temperature shall not fall below 0 °C.
- Avoid positioning the washing machine near heat sources such as coal or gas stove.
- Do not correct any unevenness in the floor by placing pieces of wood or other material under the washing machine.
- Clearance of 25mm is required for top, right, and left side. For rear, 51mm is required.

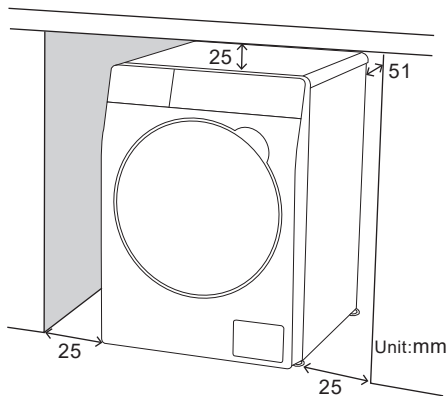

Ambient temperature

The washing machine cannot be positioned in a place where water freezes easily, because some water may be left in the water valve, drainage pump and water hose. Freeze in the pipeline may cause damage to the belt, drainage pump and other parts. The washing machine should be positioned in the environment with ambient temperature of 0°C~40°C and relative air humidity below 95% (when the temperature is 25°C), thus the washing machine can be used in a convenient and safe way.

Installation

Unpacking the washing machine

- After remove the carton box and transport materials, lift up the machine and remove the foam mattress. Please make sure the foam mattress is not stuck to the bottom.
- If need to lay down the machine to remove foam mattress, please protect the side surface of machine, and lay it down on its side. Please do not lay down the machine on front/back surface.

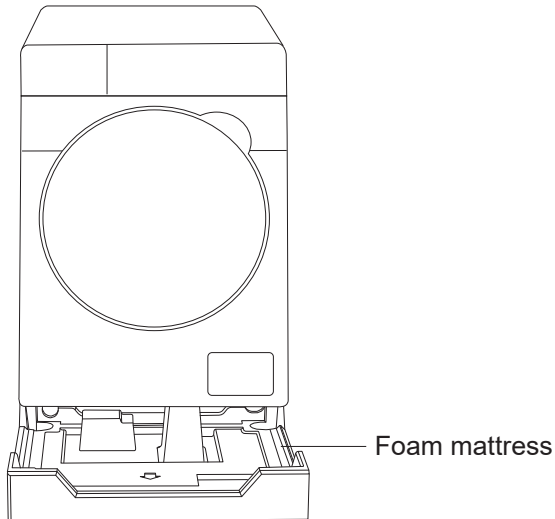

Installation

Removing the shipping bolts

Before using the washing machine, you must remove all shipping bolts from the back of the washing machine. To remove the shipping bolts:

1. Loosen all shipping bolts with the spanner.
2. Take each bolt head and pull it out from the hole. Repeat the same process for all shipping bolts.

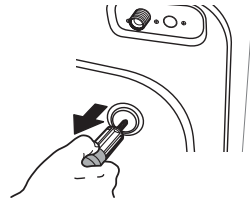
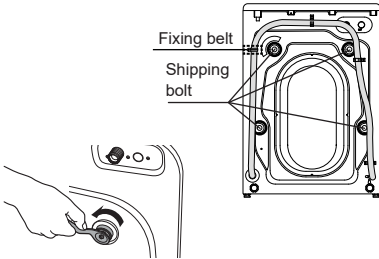

3. Fill the holes with the supplied bolt caps.
4. Keep the shipping bolts for future use.

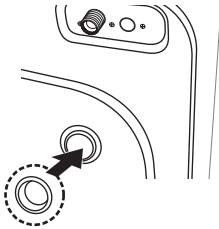

- Packing materials can be dangerous to children; keep all packing materials (plastic bags, foamed plastic, shipping bolts, etc.) well out of the reach of children.
- Do not cut off the fixing belt of the drain hose.
- Do not remove the screw fixing the belt of the drain hose.

Attaching the bottom covers

To prevent rats and small animals from entering the machine, attach the supplied bottom cover. Follow below instructions and attach the bottom cover.

Bottom view

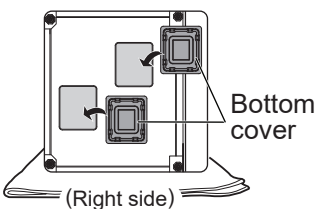

1. Lay down the washing machine gently with its right side down.



- When laying down the washing machine, lay a thick fabric or a cardboard etc. on the floor first.

2. Attach the two supplied bottom covers firmly to the bottom of the washing machine so that there are no gaps.

3. Lift the washing machine up and reposition it flat.



- Make sure not to get your feet or hands caught when you lay or pull up the washing machine.

Installation

Adjusting the adjustable feet

If the floor is uneven, adjust the adjustable feet of the washing machine. Do not insert pieces of wood or any other objects under the feet.

1. Turn left to loosen the feet nuts with the spanner.

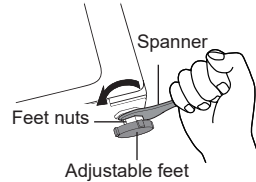

2. Adjust the adjustable feet until it is at the desired height, turn counter clockwise for higher and turn clockwise for lower.

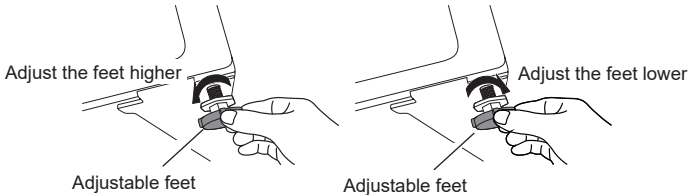

3. Tighten the feet nuts with the spanner.

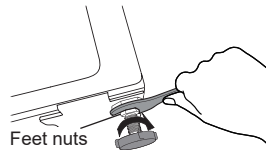

4. Check if the adjustable feet is leveled. The washing machine is level when four feet do not shake relative to the ground. The steps you can follow:

1. Press the two diagonal corners at the top of the washing machine with your hands to check if the washing machine still shakes. The two diagonals have to be checked.

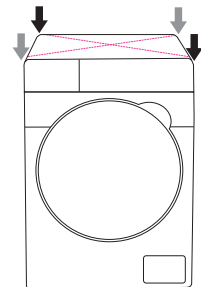

2. If the washing machine still shakes, the feet must be readjusted.

Installation

Water inlet installation

Tap selection

The front end should be longer than 10mm.

The tap exit end face should be flat and smooth, if not file it to avoid leakage.

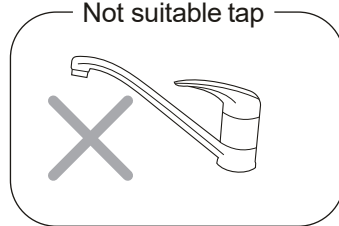
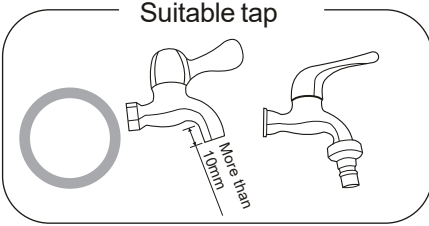

Connect the inlet hose connector to the tap

1. Press down the slider and remove the inlet hose connector from the inlet hose , like below illustration 1.
2. Loosen the four bolts on the inlet hose connector till the tap can be accessed, then set the inlet hose connector in the tap, see illustration 2. (if the tap caliber is too large and could not set the inlet hose end, unscrew the four bolts and take out the bushing, tap exit end must be flat, otherwise it will leak, see illustration 3)

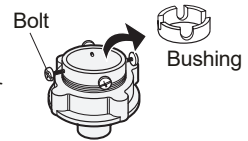
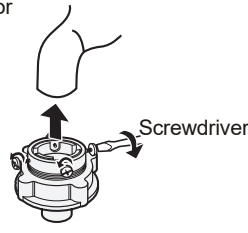
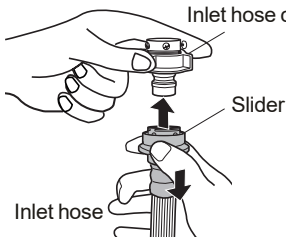

3. Fasten the four bolts on the inlet hose connector evenly, see illustration 4.
4. Twist the nut as the illustration, see illustration 5.

Note: Before twisting the nut, the threading is about 4mm above the upper surface of the nut, after twisting, the threading is less than 2mm above the upper surface of the nut, see illustration 6.

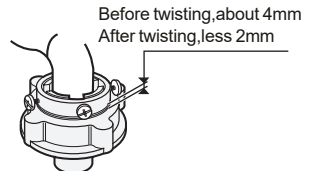
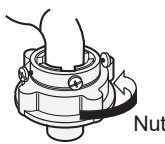
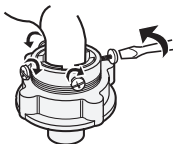

Installation

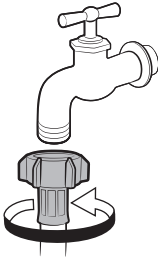

If you are using a screw type of water tap, use the provided screw-type adaptor to connect to the water tap as shown.

Positioning the drain hose

Ensure the drain hose is fixed, and the position does not move or become loose, otherwise it will cause leakage and property loss.

The end of the drain hose may be positioned in three ways:

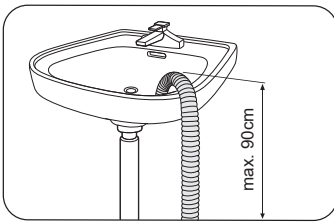

1. Over the edge of a wash basin:

The end of the drain hose must be placed at lower than 90cm from the ground. To avoid the influence of the drain hose bending on water flow, secure it over the edge of the wash basin with a hook or a piece of string to prevent the drain hose from moving.

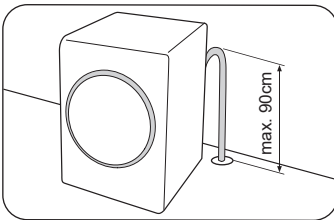

2. In a floor drain directly:

Please ensure the drain hose height from the floor drain is less than 90cm.

Note: the end of the drain hose cannot be immersed in water.

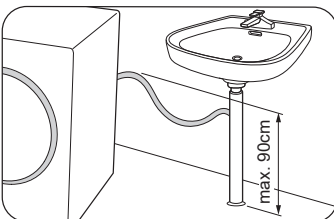

3. In a sink drain hose branch:

The end of the drain hose is connected to a sink drain hose branch. The highest point of the drain hose must be lower than 90cm.

Before using the washing machine

Inspection and preparation before washing

To prevent the fault of washing machine and the damage to laundry, you have to pay attention to the following items.

1. Sort the laundry according to soil, color and lint.

- Cotton laundry shall be turned inside out and washed separately, or other laundry may be stained with dust, lint, etc.
- Before washing, please check that if black laundry and cottons are turned inside out and washed separately since they are easily stained with lint of different colors when washed together.

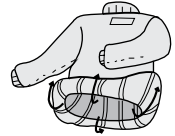

2. Take objects out from the pocket.

- Please check and empty the pockets of the laundry. Hard objects such as decorations and coins may damage the washing machine or result in abnormal fault.

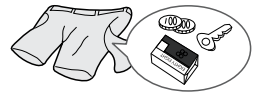

3. Before washing the laundry, take off the metal decorations and zip up the laundry, buckle the collar, then turn the laundry inside out.

- Before washing jeans and overalls with hard objects such as zippers and buttons, they should be closed or buttoned up. Winter jacket, overalls, bedspread, jeans etc. shall be washed separately.
- Clothes shall be straightened out before putting into the washing machine; curtains with hooks shall be washed after the hooks are taken off. Laundry with buttons or embroidery shall be washed after the laundry is turned inside out.
- Please take off the decorations on the clothes before washing since they may damage the laundry. All kinds of strings shall be properly tied since they may twine other laundry.



Before using the washing machine

4. Small articles such as underwear must be washed in a washing mesh bag.

- Underwear with metal hooks should be washed in a washing mesh bag to prevent the metal from rupturing through the underwear to damage the laundry and inner drum.
- Small articles such as stockings are recommend to be washed in a washing mesh bag (available in market) to prevent them from falling into the door seal.

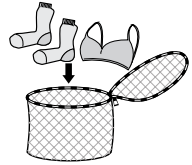

5. Pre-wash areas such as white stockings, collars, cuffs in advance.

- Please wash the areas in advance such as cuffs, collars, and pockets with a brush before machine washing.
- Please use powder or liquid detergents. Soap residues may remain in the seams of the clothes or in the washing drum when washing with soaps.

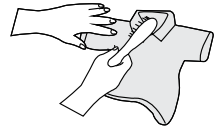

6. Before washing, please confirm if there are stains on the laundry.

- Do not place the laundry in the washing machine for a long time since they may get mildew and stains.
- Confirm if the laundry washed for the first time are fading. Wipe the inconspicuous tails of the laundry with a white towel stained with detergent to see if the towel is dyed with the color of the laundry.



7. Clean dust, sludge and hairs of the pet attached on the laundry.

- Friction of dust and sludge with the laundry may damage the clothes and affect washing results.



8. To protect the skin of the baby.

- Baby's laundry (baby's clothes and towels) such as diapers shall be washed separately. Try to avoid washing with the laundry of adults.



Before using the washing machine

Using methods of detergents and additives

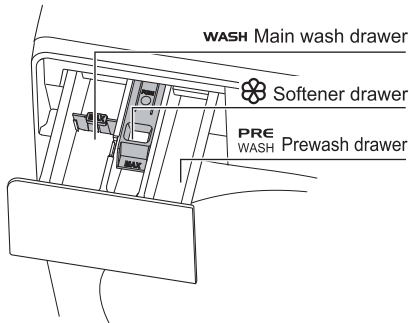

WASH Main wash drawer—Washing powder or liquid

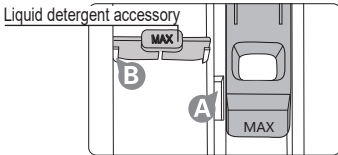

- When using the liquid detergents, put the detergent accessory in site B.

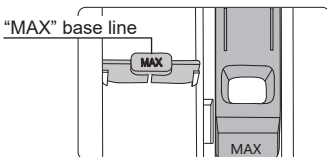

- The amount of liquid detergents shall not exceed "MAX" base line.

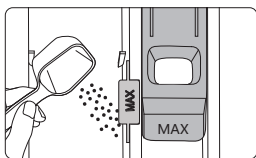

- Do not put in liquid detergent accessories when using powder detergent.

Softener drawer—Softener

- During the last rinsing, softeners in the detergent drawer will be poured automatically.
- The amount of liquid detergents shall not exceed "MAX" base line.
- Do not put powder or liquid detergents in the softener drawer.

PRE WASH Prewash drawer—Powder detergent

If you select the program with the pre-wash function, please put a little powder detergent in the prewash drawer and appropriate amount of powder detergent in the main wash drawer. Powder detergent in the prewash drawer can clean part of dirt on the laundry, then powder detergent or liquid detergent in the main wash drawer can clean the laundry at a deeper level to save the detergents.



- Never open the detergent box when the washing machine is running.
- CAUTION**
- Use "low foam" detergent specific to the drum washing machine.
 - Do not use excess detergent, or too many foams will affect rinsing effect or cause functional fault.
 - Refer to the instructions of detergent manufacturer, and use proper detergent based on the type, color, water temperature, degree of stain etc. of the clothing to be washed.
 - Using right amount of detergent helps achieve good washing effect and protect the environment.
 - Do not use capsule detergent.
 - If you use liquid detergent in a reservation or pre-washing function, it may get harden. Do not use liquid detergent.
 - If detergent spills over parts except for detergent dispenser, wipe it away immediately with wet cloth, or it may result in damage.

Operations

Control panel

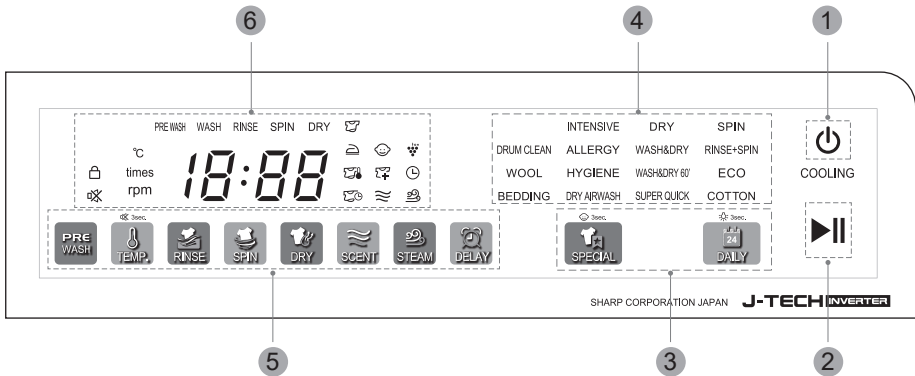

- 1 Power button**
 - Press this button to turn on or off the washing machine.
- 2 Start/Pause button**
 - Press this button to start or pause the program.
 - If a temporary stop of the program is needed, press **Start/Pause**.
- 3 Program mode buttons**
 - Select **DAILY** or **SPECIAL** according to the type of laundry.
 - The indication of selected program mode button will blink.
- 4 Program name**
 - Select the program according to the type of laundry.
 - The indication of selected program will blink.
- 5 Manual setting buttons / Feature buttons**
 - Several options and functions can be customized. For more information on each option, see page 23.
 - Available options vary depending on the program.
- 6 Display**
 - The display shows the settings (temperature, times, and rpm), estimated remaining time, options, status, and error codes. For more information on indication, see page 38.

NOTE

- Washing machine is automatically turned off when there is no operation in the last 5 minutes, or when program/anti-crease process is finished.
- Do not touch the control panel with wet hands or with gloves, bandages etc. Touch directly with finger.
- Do not apply any sharp objects to the control panel in order to operate the washing machine.

Operations

Simple steps to start

Washing, Washing and Drying

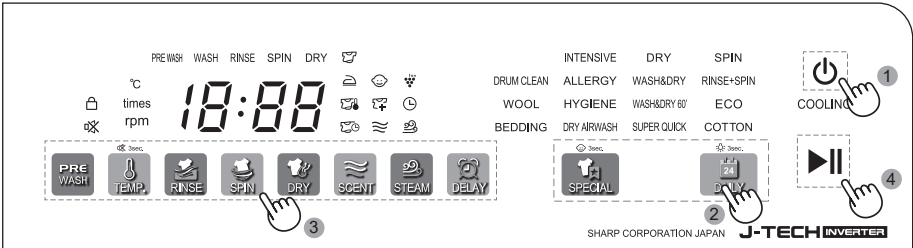

- 1 Press **Power** to turn on the washing machine.
- 2 Press **DAILY** (see page 21) or **SPECIAL** (see page 22,23) to select program.
- 3 Set options (**DRY**, **TEMP.**, etc.) as necessary. Available options differ depending on the selected program (see page 23) .
- 4 Press **Start/Pause**.

Drying only

Follow these steps to dry damp laundry.

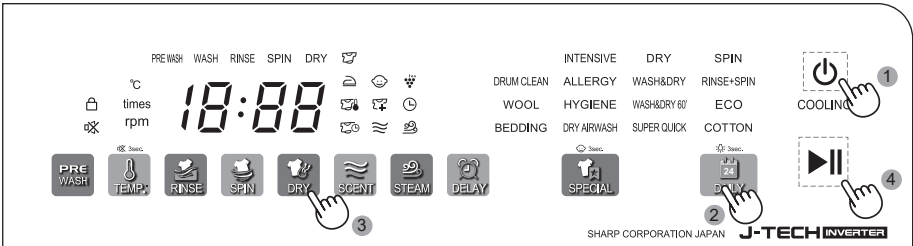

- 1 Press **Power** to turn on the washing machine.
- 2 Press **DAILY** repeatedly to select **DRY**.
- 3 Set options (**DRY** or **DELAY**) as necessary.
- 4 Press **Start/Pause**.

NOTE

- Program operation can be paused or resumed with **Start/Pause**.
- Manual Settings can be changed when program is paused.

Operations

Program overview

Selectable programs with **DAILY**

Program	Description	Rated capacity	Program		
			Max load	Max spin speed	Proper temperature
COTTON	<ul style="list-style-type: none"> Suitable for washing generally or slightly soiled cotton textiles, linen bed sheet, linen table cloth, underwear, towels, shirts, etc. 	10.5kg	10.5kg	1400rpm	40 °C (Cold to 90 °C)
ECO	<ul style="list-style-type: none"> Suitable for washing normally soiled clothes. This program consumes less energy and water. 	10.5kg	10.5kg	1400rpm	60 °C (Cold to 90 °C)
RINSE+SPIN	<ul style="list-style-type: none"> Suitable for clothing that only needs rinsing or to be rinsed once more by using fabric softener. 	10.5kg	10.5kg	1400rpm	-
SPIN	<ul style="list-style-type: none"> This program is to perform the dewatering program only, drying up the water in the clothing. 	10.5kg	10.5kg	1400rpm	-
SUPER QUICK	<ul style="list-style-type: none"> This program finishes within 15 minutes. Suitable for washing slightly soiled clothing. Using less amount of detergent is recommended for this program with short washing time. 	10.5kg	2.0kg	1400rpm	20 °C (Cold to 40 °C)
WASH&DRY 60'	<ul style="list-style-type: none"> This program finishes washing and drying within 60 minutes. Only for slightly soiled chemical fiber clothes. Using less amount of detergent is recommended for this program with short washing time. 	10.5kg	1.0kg	1400rpm	40 °C (Cold to 40 °C)
WASH&DRY	<ul style="list-style-type: none"> Suitable for washing and drying cotton, linen, blended fabrics. 	10.5kg	7.0kg	1400rpm	40 °C (Cold to 90 °C)
DRY	<ul style="list-style-type: none"> This program is for drying only of cottons, linens. 	10.5kg	7.0kg	-	-

Operations

Selectable programs with **SPECIAL**

Program	Description	Rated capacity	Program		
			Max load	Max spin speed	Proper temperature
DRY AIRWASH	<ul style="list-style-type: none"> This program is to remove bacteria and deodorizing of clothing by using PCI. The type of laundry and performance vary depending on the operating time. Please take out clothing immediately after program is finished. <p>To change modes, see page 23.</p> <p>Still Mode</p> <ul style="list-style-type: none"> - 5 minutes: hat, stuffed toys, leather goods and silk, only deodorizing - 10 minutes: hat, stuffed toys, leather goods and silk, both deodorizing and removing bacteria - 30 minutes: hat, stuffed toys, leather goods and silk, both deodorizing and removing bacteria <p>Rotation Mode</p> <ul style="list-style-type: none"> - 5 minutes: light clothing, only deodorizing - 10 minutes: light clothing, both deodorizing and removing bacteria - 30 minutes: thick clothing and big items (sheets, etc.), both deodorizing and removing bacteria 	10.5kg	1.0kg	-	-
HYGIENE	<ul style="list-style-type: none"> This program is to wash heavily soiled clothing and remove allergen such as house mite. Prewash process and Steam process is installed in the program and cannot be deselected. Suitable for washing cotton and linen. 	10.5kg	4.0kg	1400rpm	60 °C (60 to 90 °C)
ALLERGY	<ul style="list-style-type: none"> This program is to remove allergen such as house mite using steam. Suitable for washing cotton, linen, and other daily clothes. Steam process is installed in the program and cannot be deselected. 	10.5kg	4.0kg	1400rpm	60 °C
INTENSIVE	<ul style="list-style-type: none"> Suitable for washing moderately or heavily soiled cotton textiles. 	10.5kg	2.0kg	1400rpm	60 °C (Cold to 90 °C)
BEDDING	<ul style="list-style-type: none"> Suitable for washing bedspread, bed sheet, quilt cover, etc. 	10.5kg	2.0kg	800rpm	Cold (Cold to 40 °C)
WOOL	<ul style="list-style-type: none"> Suitable for washing wools that are machine washable. 	10.5kg	2.0kg	800rpm	30 °C (Cold to 40 °C)
DRUM CLEAN	<ul style="list-style-type: none"> This program is to clean the drum by removing dirt and bacteria from it. Make sure the drum is empty. Do not use any cleaning agents for cleaning the drum. 	-	-	800rpm	90 °C

Operations

NOTE

Before starting **DRY AIRWASH**

- Please remove solid dirt such as lint, sand, and pet hair.
- If the inside of the drum or door is wet, wipe it off with a dry cloth.
If you start the program while it is wet, the item inside will be wet.

Available options list

Program	Available options							
	PREWASH	TEMP.	RINSE	SPIN	DRY	SCENT	STEAM	DELAY
COTTON	●	●	●	●	●	●	●	●
ECO	●	●	●	●	●	●	●	●
RINSE+SPIN			●	●	●	●		●
SPIN				●	●			●
SUPER QUICK		●	●	●				●
WASH&DRY 60'		●						●
WASH&DRY	●	●	●	●	●	●	●	●
DRY					●			●
DRY AIRWASH					*1			●
HYGIENE	●*2	●	●	●	●	●	●*2	●
ALLERGY			●	●	●	●	●*2	●
INTENSIVE	●*2	●	●	●	●	●	●	●
BEDDING		●	●	●		●	●	●
WOOL		●	●	●		●		●
DRUM CLEAN								

*1 **DRY AIRWASH** has two modes. The rpm LED is blinking when Rotation Mode is selected.

By pressing **DRY**, remaining time indication changes to
 0:30 (default) → 0:05 → 0:10 → 0:30 → 0:05 → 0:10 → 0:30 (default) ...

⏟
⏟

Still Mode
Rotation Mode

*2 This option is installed in the program and cannot be deselected.

Operations

Function buttons



PREWASH

Use this function to add preliminary wash before the main wash.



TEMP.

You can select the appropriate water temperature according to the cloth.

Press repeatedly to select water temperature in sequence: cold, 20°C, 30°C, 40°C, 60°C and 90°C.

NOTE

- If **STEAM** function is already valid, the available temperature settings are : 60°C and 90°C.



RINSE

You can select the appropriate rinse times according to the cloth.

NOTE

- If **SCENT** function is already valid, the available rinse times settings are from 2 times to 5 times.



SPIN





You can select the appropriate speed according to the cloth. No Spin is described with "0" on Display. The drum does not rotate after the final draining process.







DRY

You can select Dry Level.

Press repeatedly to select Dry Level in sequence. You can select: **Normal, Iron, Low Temperature, Dry Timer** (0:30, 1:00, 2:00, 3:00, 4:00, blank (Off)).

- When **Normal** is selected , the icon () blinks;
- when **Iron** is selected , the icon () blinks;
- when **Low Temperature** is selected, the icon () blinks;
- when **Dry Timer** (0:30, 1:00, 2:00, 3:00, 4:00) is selected, the icon () blinks

Operations

Dry Level		Description	Rated capacity	Max load
Normal 		Suitable for drying cotton and linen. At the end of program, clothes can be put away in cupboard.	10.5kg	7.0kg
Iron 		Suitable for cotton and linen. At the end of program, clothes will be damp, ready for ironing.	10.5kg	7.0kg
Low Temperature 		Suitable for drying synthetics and heat sensitive clothes. This mode dries clothes in low temperature for less damage.	10.5kg	3.5kg
Dry Timer 	0:30	Manually select specified time to dry your laundry, depending on the material, amount of laundry, and moisture.	10.5kg	-
	1:00			
	2:00			
	3:00			
	4:00			

NOTE

- Keep the water inlet faucet open when washing. Otherwise, the washing process may not function.
- Do not overload the maximum load for each drying level. This may result in poor performance.
- Do not use the drying function after applying a chlorine bleach agent to the laundry during a wash or drying. Otherwise, the laundry may become discolored or the material may be damaged.
- Do not use the drying function for clothing with fur lining or made from acrylic material. This may result in the drying function being degraded.
- Do not dry wool, silk, leather or other protein fiber materials.
- Do not dry any clothing that is susceptible to discoloration or cracking, such as garments that have lace or printing. .
- Do not touch the insides of the drum or the washing machine surface during or just after drying as it may be hot. This may result in burns.
- COOLING lamp lights up when the operation is paused while internal temperature of the drum is high and cooling down is in progress.
- The drying result may vary depending on the selected program, amount and type of laundry.
- To ensure drying results, operate **SPIN** program with highest spin speed, when drying clothes which is not enough dehydrated.
- In this process, the display is blinking "0:00", but the door can be unlocked by pressing the **Start/Pause** or **Power** to remove the clothes.

When **Start/Pause** or **Power** is not pressed, it enters anti-creasing process to prevent crease which continues for 2 hours until **Start/Pause** or **Power** is pressed.

If COOLING is lit the temperature inside the cabinet is too high to remove the clothes.



SCENT

Wash clothing effectively to last softener scent. The clothing will be soaked in water with softener.

When this function is set, the feature icon () will be lit.

NOTE

- If the current set rinse times are below 2 times, the rinse times setting will automatically be changed to 2 times.

Operations



STEAM

Use this function to use the enhanced washing performance.
When this function is set, the feature icon (☁) will be lit.

NOTE

- This option is installed in the programs (**HYGIENE** and **ALLERGY**) and cannot be deselected.
- If the current set temperature is below 60°C, the temperature setting will automatically be changed to 60°C.



DELAY

You can select preset time (delay timer).
Press repeatedly to select preset time in sequence.
When preset time is set, delay timer icon (⌚) will be lit.

NOTE

- The preset time is from 3 hours to 24 hours. No preset is allowed under 3 hours.
- Clothes that are prone to static electricity are not suitable for the preset function.
- After **Start/Pause** is pressed, the time until the end of program is indicated on Display.

Icons



Plasmacluster Ion (PCI)

PCI icon lights up when a program which includes PCI function is selected, and blinks when PCI function is activated during following processes and programs.

- Drying process
- Drying process of **DRUM CLEAN** program
- Anti-crease process
- **DRY AIRWASH** program

PCI function of **DRY AIRWASH** function removes unpleasant smells and bacteria on clothing.

In addition, drying process of **DRUM CLEAN** program prevents growth of mold.

Operations

Add laundry

Press **Start/Pause** to add clothes. When the icon is on, door can be unlocked. Adding laundry is acceptable in the washing or rinsing process in below.

- Water level is lower than door locking water level
- Water temperature is lower than 55°C

Door lock

When the door lock is in the closed state, the icon is on; when the door lock is in the open state, the indicator icon is off.

Child lock

Press and hold **SPECIAL** for 3 seconds, the child lock function will be turned on or off, and the child lock indicator will turn on or off.

This function can lock all the buttons except the **Power** button and the child lock button.

Child lock cannot be turned on when 0:00 is blinking on **Display** after program operation ended.

NOTE

- Once the child lock function is turned on, this setting is memorized even after the washing machine is turned off. When the washing machine is turned on again, the program will resume from where it has been paused. To operate other buttons except **Power**, turn off the child lock repeating procedure explained above.

Mute

In the standby state, press and hold **TEMP.** for 3 seconds to turn on and off the mute function.

When this icon is on, the machine will not output sound, except for error sounds.

Drum light

When the machine is on, press and hold **DAILY** for 3 seconds to turn on or off the drum light. The longest lighting time is 1 minute.

When the door is opened, the drum light turns on automatically as default setting. Change the setting in setting mode as necessary(see page 28).

Operations

Setting mode

To activate setting mode, hold down **PREWASH, TEMP., RINSE** simultaneously for 3 seconds when the washing machine is turned on. Setting mode can be activated before program is started.

Setting buttons in below table and **Start/Pause** is lighting in this mode.

Setting mode is completed after **Start/Pause** has been pressed.

The washing machine is automatically turned off after **Start/Pause** has been pressed.

Setting mode	Setting button	Contents
Water level	RINSE	"0" or "1" is toggled on display by pressing RINSE . 0: standard water level (default) 1: water added than standard level Available programs: COTTON, WASH&DRY
Dry level	DRY	"0", "1", "2" is toggled on display by pressing DRY . 0: standard drying level (default) 1: increased drying level 2: decreased drying level Available programs: COTTON, ECO, WASH&DRY 60', WASH&DRY, DRY
Drum light	DAILY	"0", "1", "2", "3" is toggled on display by pressing DAILY . 0: drum light off 1: low 2: middle (default) 3: high
Factory reset	DELAY	Reset the setting to factory setting by pressing DELAY .

Maintaining the washing machine

Cleaning the detergent dispenser

Clean the detergent dispenser when detergent and softener accumulate.

1. Press the release lever on the inside of the detergent dispenser and pull it out. Then remove accessories from the drawer.



Make sure not to drop detergent dispenser when pulling it out.

CAUTION

Release lever

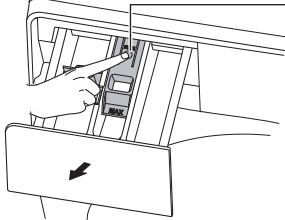

2. Wash all recesses under running water and clean the drawer and recesses with a small brush.

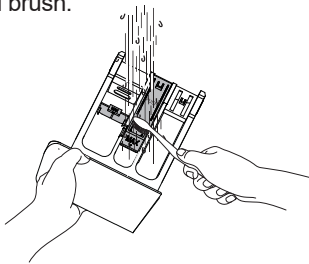

3. Reinsert the accessories and replace the detergent dispenser into the recess; make sure that detergent dispenser is pushed back into place.

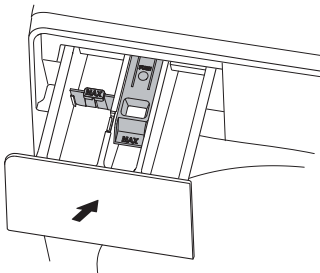

Cleaning the enclosure

Keep the washing machine clean to enhance the performance, avoid unnecessary maintenance and increase the service life. Before cleaning the washing machine, the machine shall be unplugged.

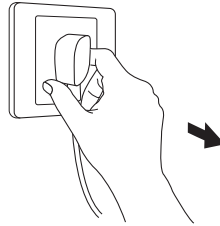

Wipe the washing machine exterior with a soft cloth and non-abrasive household detergents. For the control panel, wipe off with soft cloth.

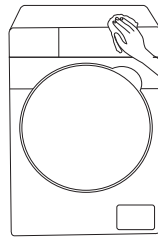

Do not pour water on the exterior in case parts of the machine would be damaged.

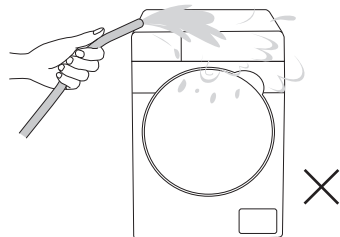

Maintaining the washing machine

Keep the washing machine clean to enhance the performance, avoid unnecessary maintenance and increase the service life.

Drum cleaning

This is an auto drum clean program and can remove the possibly bred mold in the drum.

1. Turn on the water supply faucet.
2. Put appropriate amount of cleansers in the detergent drawer and close the detergent drawer.
3. Touch the screen and select the **DRUM CLEAN** program.
4. Press **Start/Pause** button to start the **DRUM CLEAN** program.
 - The **DRUM CLEAN** program cannot be used when there are clothes in the washing machine, or the laundry or machine may be damaged.
 - Ordinary detergents cannot be used for the **DRUM CLEAN** program.
 - Only one tenth of drum cleanser amount recommended by the manufacturer shall be used for the sake of environmental protection.
 - Powder cleanser: Please use powder bleach or the cleanser specialized for the inner drum of the washing machine.
 - Liquid cleanser: Please use liquid oxygen bleach or the cleanser specialized for the inner drum of the washing machine.

Cleaning the drain pump filter

Before cleaning and maintenance, please pull the power cord out from the socket. Clean the drain pump filter 5 to 6 times a year is recommended; or when you see the "E03" error message on the display clean the filter.

1. Push to open the filter cover of the washing machine.
2. Pull out the drain tube, pull the stopper, let water flow to a container.

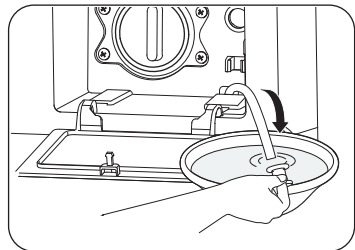
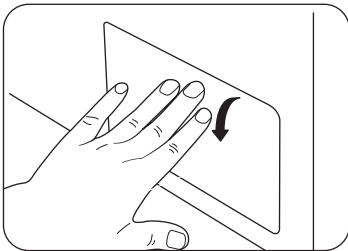

Maintaining the washing machine

3. Unscrew the pump filter by turning left and drain off all the water.

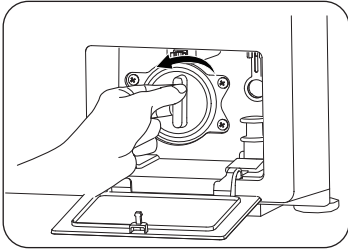

4. Wash any residue and stain from the filter and make sure the inside of the drain pump is not blocked.

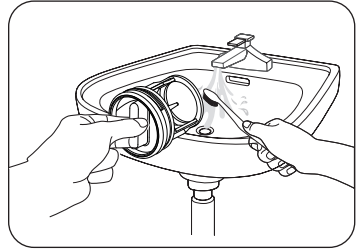

5. Reinsert the drain pump filter.

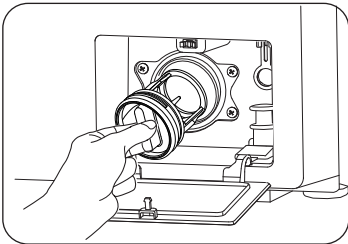

6. Install the drain pump filter by turning right and close the filter cover.

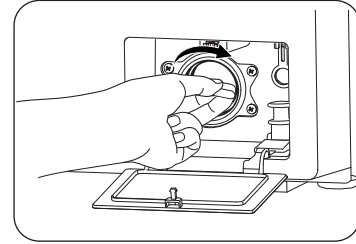

- WARNING**
- Don't unscrew the drain pump filter when the machine is in operation or when hot water is flowing out.
 - Make sure the filter is replaced into the machine when the cleaning is finished. Otherwise, fault or water leakage may occur.
 - Make sure the filter is assembled in place.
 - In case of emergency, drain water with this procedure.

Maintaining the washing machine

Cleaning the water supply valve filter

You should clean the supply valve filter from time to time or when you see "E01" error message on the display:

1. Pull out the power plug and turn off the water supply faucet of the washing machine.
2. Unscrew the water supply hose from the back of the machine.

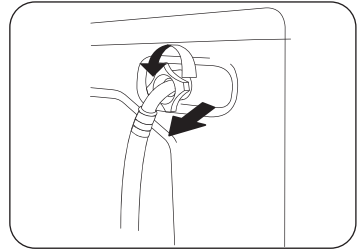
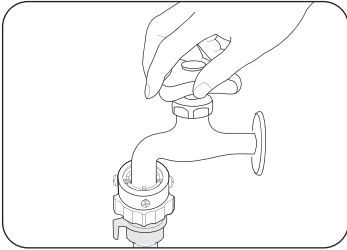

3. With a pair of pliers, gently pull out the water supply valve filter from the valve connector and rinse it under water until clean.
4. Clean the inside and outside of the threaded connector.

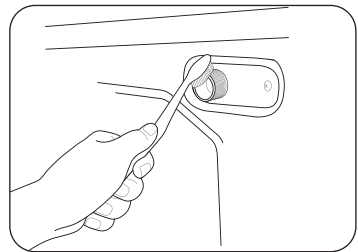
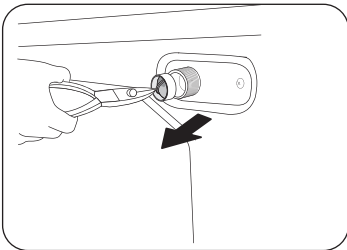

5. Push the filter back into the original place.
6. Reconnect the water supply hose. Turn on the faucet and make sure the connections are watertight.

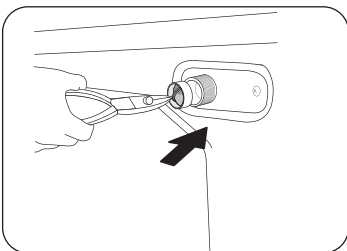

Maintaining the washing machine

Handling the frozen washing machine

If the temperature drops below 0 °C and your washing machine is frozen, you can:

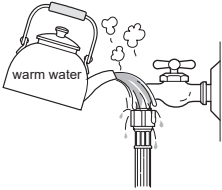

1. Wrap up the faucet with the towel soaked in warm water and pour warm water on it to unfreeze the water supply hose.

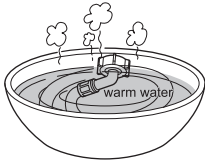

2. Remove the water supply hose and soak it in warm water.

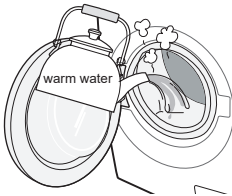

3. Pour warm water into the washing machine drum and let it sit for 10 minutes.

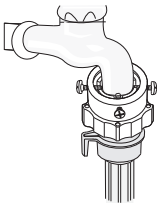

4. Reconnect the water supply hose to the water faucet and check if the water supply and drain operations are normal.
 - When using the washing machine again, please make sure that the ambient temperature is above 0 °C.

Storing the washing machine

If you need to store your washing machine for a long time, please drain the residual water out from the machine. Otherwise, the residual water will remain in your washing machine for a long time and damage your machine.

1. Select the **SPIN** program to drain the water in the drum.
2. Pull out the drain tube, pull the stopper, let water flow to a container.
3. Turn off the water faucet and separate the water supply hose.
4. Unplug the washing machine and open the machine door to allow ventilation.

Troubleshooting

Problems and solutions

Phenomenon	Solution
Detergent is left in the detergent dispenser after a program is finished	<ul style="list-style-type: none">• Check if the water pressure is sufficient when washing.• Check if the detergents are put in the injection port of the body drawer.• Check if the washing powder are damp and caking.
The pre-wash detergents in the detergent dispenser do not flow into the drum	<ul style="list-style-type: none">• Check if the washing program with the pre-wash function is selected.
Washing machine vibrates or is too noisy	<ul style="list-style-type: none">• Check if the washing machine is set on an uneven surface. If the surface is uneven, adjust the adjustable feet to level the washing machine.• Check if the shipping bolts are removed.• Check if the washing machine is touching any other objects.• Check if the laundry load is balanced in the inner drum of the washing machine.
The displayed washing time deviates from the actual washing time	<ul style="list-style-type: none">• There is deviation in the weight of laundry, watery supply time and balancing time.
The drainage pump has abnormal noise	<ul style="list-style-type: none">• Check if the drainage pump filter is blocked by laundry flocks and clean the drain pump filter timely to erase the noise.
Washing machine does not start.	<ul style="list-style-type: none">• Make sure the washing machine is plugged in.• Make sure to press Start/Pause to start the washing machine.• Make sure Child Lock is not activated.• Check the fuse or reset the circuit breaker.
Water supply does not start, or is insufficient	<ul style="list-style-type: none">• Fully open the water tap.• Make sure the door is properly closed.• Make sure the water supply hose is not frozen.• Make sure the water supply hose is not kinked or clogged.• Make sure there is sufficient water pressure.

Troubleshooting

Phenomenon	Solution
<p>Washing machine does not drain and/or spin</p>	<ul style="list-style-type: none"> • Make sure the drain hose is straightened all the way to the drain system. If you encounter a drain restriction, call for service. • Make sure the drain pump filter is not clogged. • Close the door and press or tap Start/Pause. For your safety, the washing machine will not tumble or spin unless the door is closed. • Make sure the drain hose is not frozen or clogged. • Make sure the drain hose is connected to a drain system that is not clogged. • If the washing machine is not supplied with sufficient power, the washing machine temporarily will not drain or spin. • As soon as the washing machine regains sufficient power, it will operate normally.
<p>Door does not open</p>	<ul style="list-style-type: none"> • Press or tap Start/Pause to stop the washing machine. • It may take a few moments for the door lock mechanism to disengage. • Make sure all the water in the drum is drained. • The door may not open if water remains in the drum. Drain the drum and open the door manually. • Make sure the door lock light is off. The door lock light turns off after the washing machine has drained. • Check the washing machine is in cooling, and the door lock cannot be opened until the cooling is over. • Check the washing machine is in working, and the door lock cannot be opened until the motor stop.
<p>Water is leaking</p>	<ul style="list-style-type: none"> • Make sure the door is properly closed. • Make sure all hose connections are tight. • Make sure the end of the drain hose is correctly inserted and secured to the drain system. • Avoid overloading. • Use "low foam" detergent to prevent oversudsing.

Troubleshooting

Phenomenon	Solution
<p>Spin time is extended/ Spin speed is low</p>	<ul style="list-style-type: none"> • Because there is Fuzzy control in your machine, it can inspect the balance when spinning. In order to protect the machine, when the clothes is unbalance, it will expend the spinning time or reduce speed to keep the clothes balance, or spin in a lower speed. • When there are excessive foams, the time on the display will cease for a spell, meanwhile the machine is eliminating the foams rather than fault, and the machine will automatically return to normal program if finished.
<p>There are excessive foams. Foam is left in gasket after a program is finished</p>	<ul style="list-style-type: none"> • Make sure you use the recommended types of detergent as appropriate. • Use "low foam" detergent to prevent oversudsing. • Reduce the detergent amount for soft water, small loads, or lightly soiled loads.
<p>Button does not respond</p>	<ul style="list-style-type: none"> • Check if control panel is clean. Wipe off water or dirt with soft cloth. Remove stickers or tapes. • Touch the panel directly with finger. Operating with gloves, bandages, nails, or other sharp objects does not respond. • Press the center of the button. • Do not take your finger off the button immediately. • Check if multiple buttons are not pressed.
<p>There is smell of rubber comes from the washing machine</p>	<ul style="list-style-type: none"> • Rubber smell may come from the washing machine when using drying function in the beginning. • The smell will be reduced with the use of drying function.
<p>Drying performance is poor</p>	<ul style="list-style-type: none"> • Select the highest spin speed available. • Do not overload. • Sort heavy items from lightweight items. • Check the water inlet and outlet is in normal situation. • Make sure the drain pump filter is not clogged.
<p>It takes too much time to dry</p>	<ul style="list-style-type: none"> • Ensure the program is set correctly. • Decrease the amount of clothes. • Clothes must be fully dehydrated before put into drum. • Please confirm whether the ambient temperature is within the allowable range.

Troubleshooting

Phenomenon	Solution
18:88 is indicated on Display when the washing machine is turned on	<ul style="list-style-type: none"> • Hold PREWASH and Power simultaneously for 3 seconds when 18:88 is indicated on Display.
Clothing is damaged from DRY AIRWASH program	<ul style="list-style-type: none"> • Check suitable clothing for DRY AIRWASH program.
There is smell in the drum after DRY AIRWASH program	<ul style="list-style-type: none"> • Smell may stay in the drum, immediately after the program is finished. • Smell can be removed with regular washing programs, or with DRUM CLEAN program.
Smell is not removed with DRY AIRWASH program	<ul style="list-style-type: none"> • Check if the laundry was taken out immediately after the program was finished. • Depending on the type and strength of clothing and smell, it may not be possible to deodorize sufficiently. • If clothing is not deodorized sufficiently, operate the program again, or try regular washing programs, or dry cleaning. <p>NOTE: Smell in below items may not be deodorized.</p> <ul style="list-style-type: none"> Items stored for long terms. Items not washed for long terms, especially thick clothing. Items with strong pet smell.
Does Plasmacluster ion generating unit need to be changed?	<ul style="list-style-type: none"> • No need to be changed.
Does Plasmacluster ion have any effect on human body?	<ul style="list-style-type: none"> • Plasmacluster ions are the same type of positive and negative ions that occur in nature, and is confirmed that there is no adverse effect on humans.
Is no ozone generated from Plasmacluster ion?	<ul style="list-style-type: none"> • A small amount of ozone is generated, but the concentration is very small and there is no health problem.
How will the bacteria be, after they are removed?	<ul style="list-style-type: none"> • They lose their ability to be active and become equivalent to dust and dirt.

Troubleshooting

Error messages description

Error code	Code description	Solution
E 01 E01 Error	Abnormal water supply	<ul style="list-style-type: none"> • Check whether the water tap for water supply is opened. • Clean the filter cover of water inlet valve. • Check the water pressure.
E 02 E02 Error	Abnormal door lock	<ul style="list-style-type: none"> • Check if the door is opened and make sure the door is closed firmly.
E 03 E03 Error	Abnormal draining	<ul style="list-style-type: none"> • Check whether the drain hose is clogged. • Clean the filter cover of drainage pump. • Check whether the drain hose is installed correctly.
E 04 E04 Error	Imbalance alarm	<ul style="list-style-type: none"> • The clothes have too large eccentricity or get tangled; arrange them in order and put them in the drum. • Add more clothes for washing.
E 17 E17 Error	Motor does not rotate	<ul style="list-style-type: none"> • An abnormal current may have temporarily flowed through the motor. Please wait for a while, then press the start key to resume operation.
[** **.:number C Error	There is possibility of malfunction	<ul style="list-style-type: none"> • Turn off power and pull out power plug. After waiting for 1 minute, plug the power plug, turn the washing machine on. • If a "C error" occurs, please call the after-sales service department to request an inspection. • C10 errors may improve itself over time. If the C10 errors persists after restarting after half a day later, please call the after-sales service department.

If after trying solutions, and trouble is not solved, contact with the after-sales service department.